

# A-A

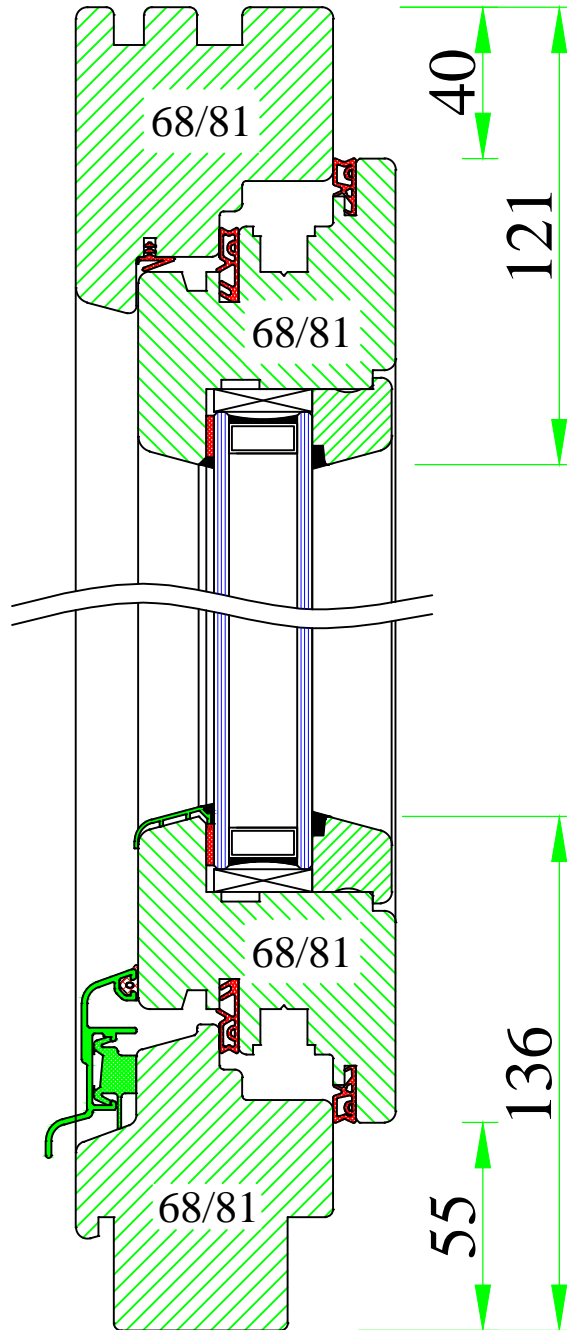

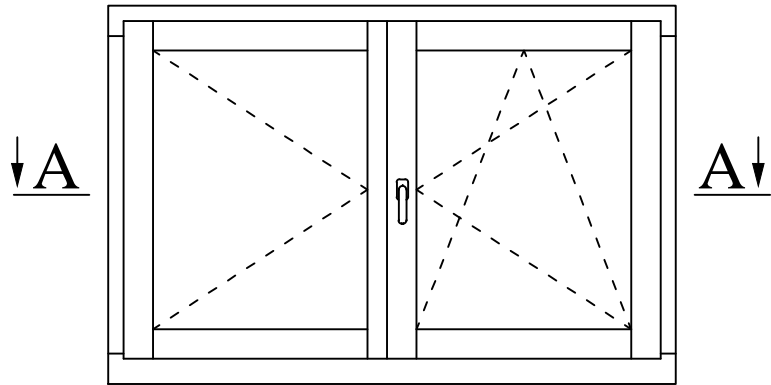

# A-A

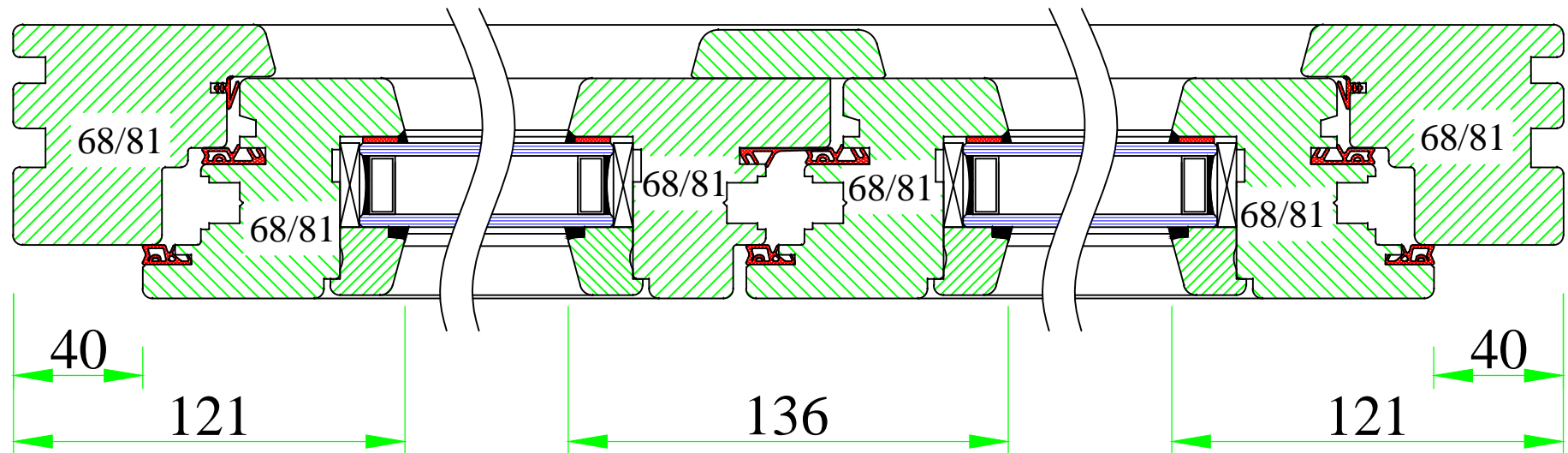

**UNI WINDOWS Ltd.**  
 Unit 6, Edgefield Industrial Est.  
 Loanhead, EH20 9TB  
 Tel.: 0131 448 3931

IV 68 NEWLINE  
 Double opening window "flying" mullion

Version: 1	Scale: 1:2
Date: 15.05.14	Drawing: NON/2

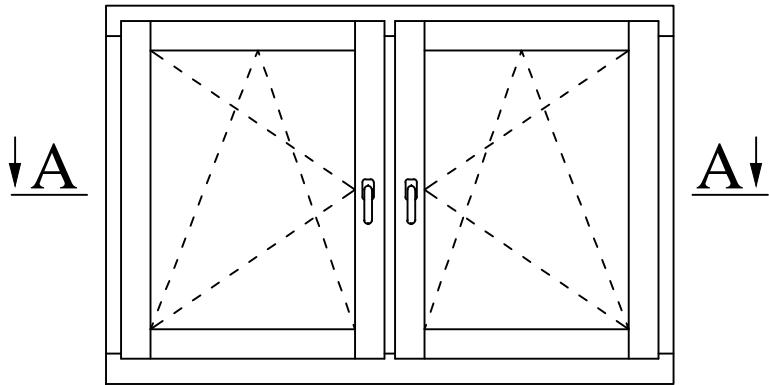

# A-A

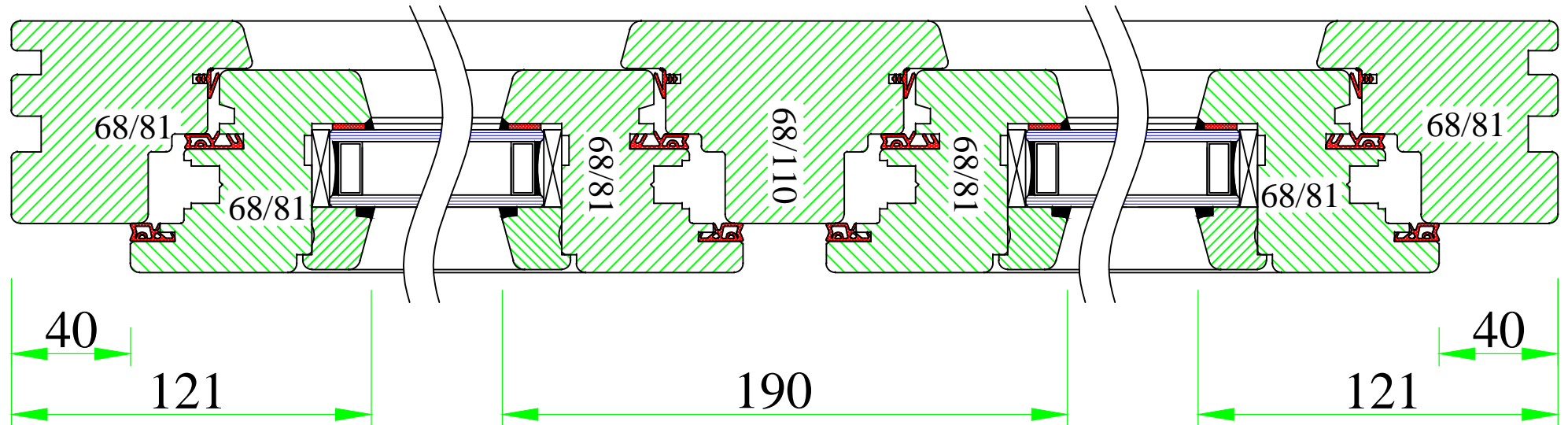

www.uniwin.co.uk



**UNI WINDOWS Ltd.**  
 Unit 6, Edgefield Industrial Est.  
 Loanhead, EH20 9TB  
 Tel.: 0131 448 3931

IV 68 NEWLINE  
 Double opening window fixed mullion 110mm

Version: 1	Scale: 1:2
Date: 15.05.14	Drawing: NON/3

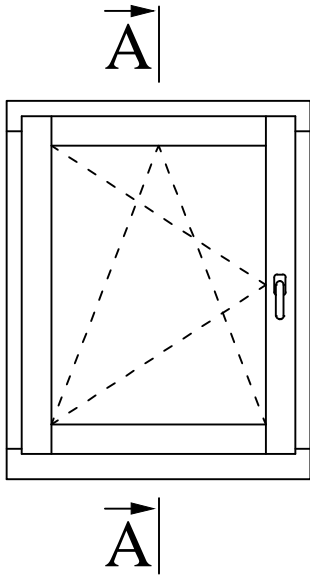

# A-A

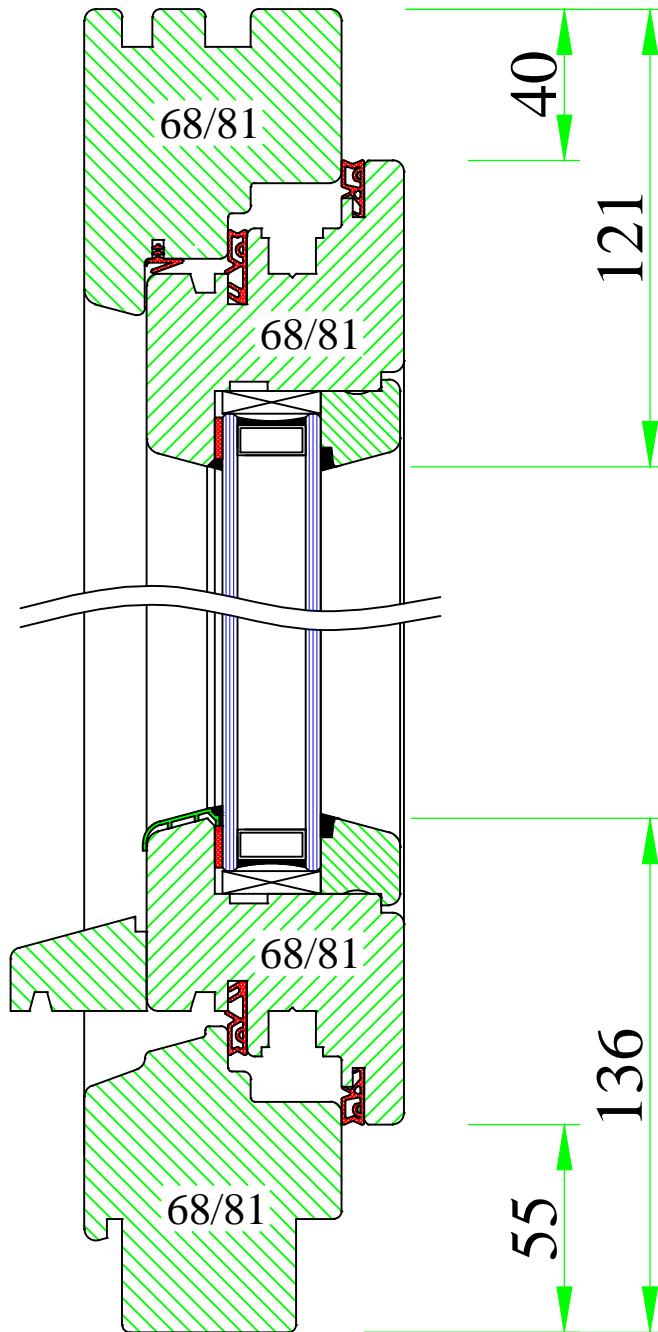

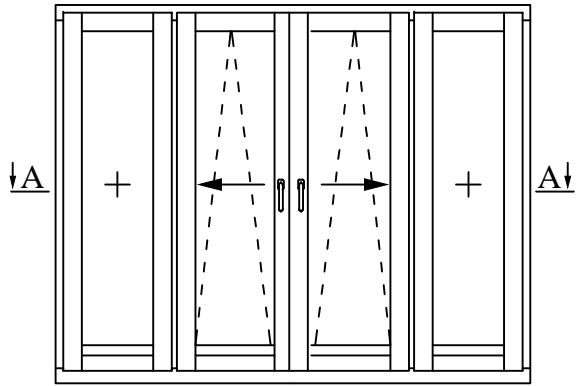

# A-A

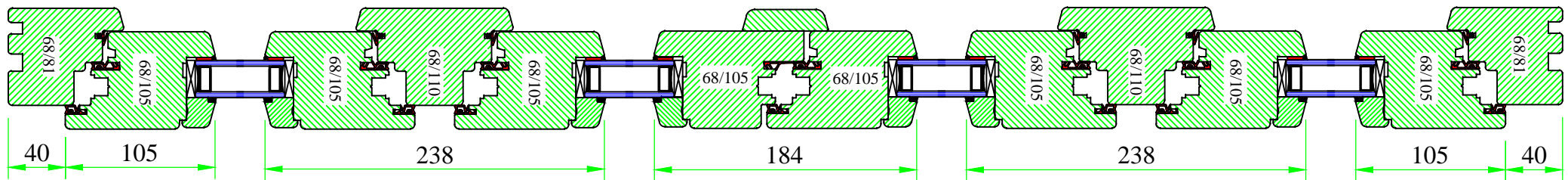

www.uniwin.co.uk



**UNI WINDOWS Ltd.**  
 Unit 6, Edgefield Industrial Est.  
 Loanhead, EH20 9TB  
 Tel.: 0131 448 3931

IV 68 NEWLINE

Tilt and slide doors; scheme C

Version: 1	Scale: 1:4
Date: 15.05.14	Drawing: NON/5

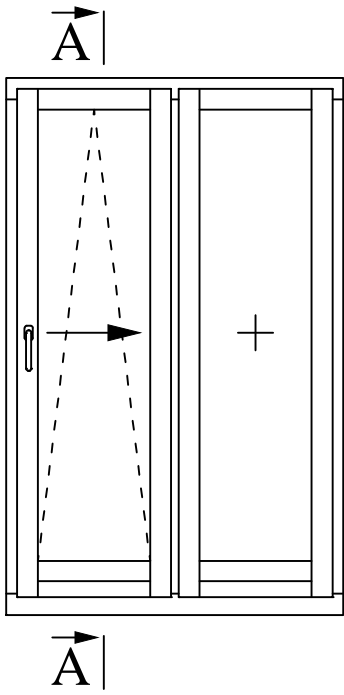

# A-A

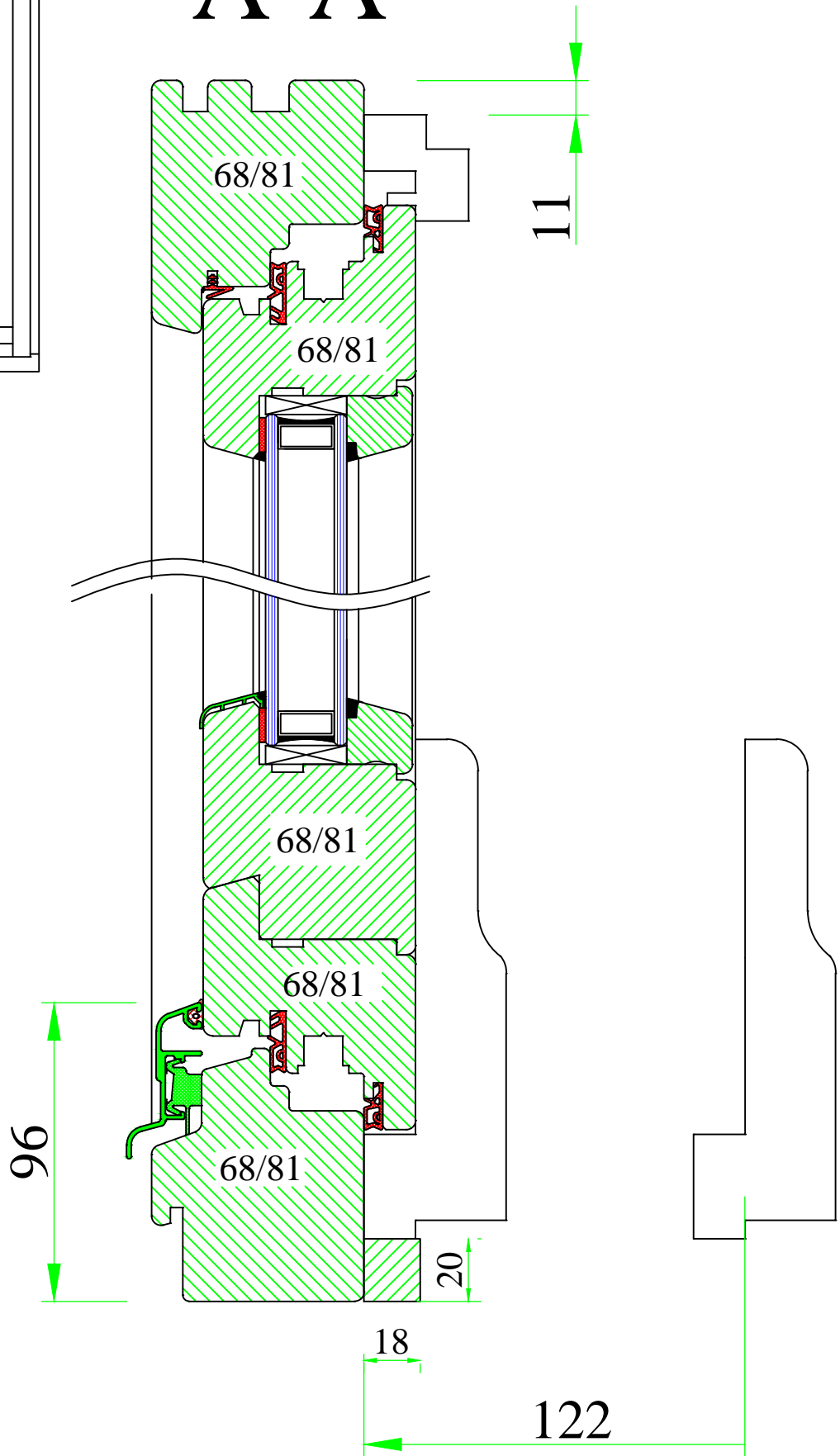

www.uniwin.co.uk



**UNI WINDOWS Ltd.**  
 Unit 6, Edgefield Industrial Est.  
 Loanhead, EH20 9TB  
 Tel.: 0131 448 3931

Tilt and slide doors

IV 68 NEWLINE

Version:  
1

Scale:  
1:2

Date:  
15.05.14

Drawing:  
NON/8

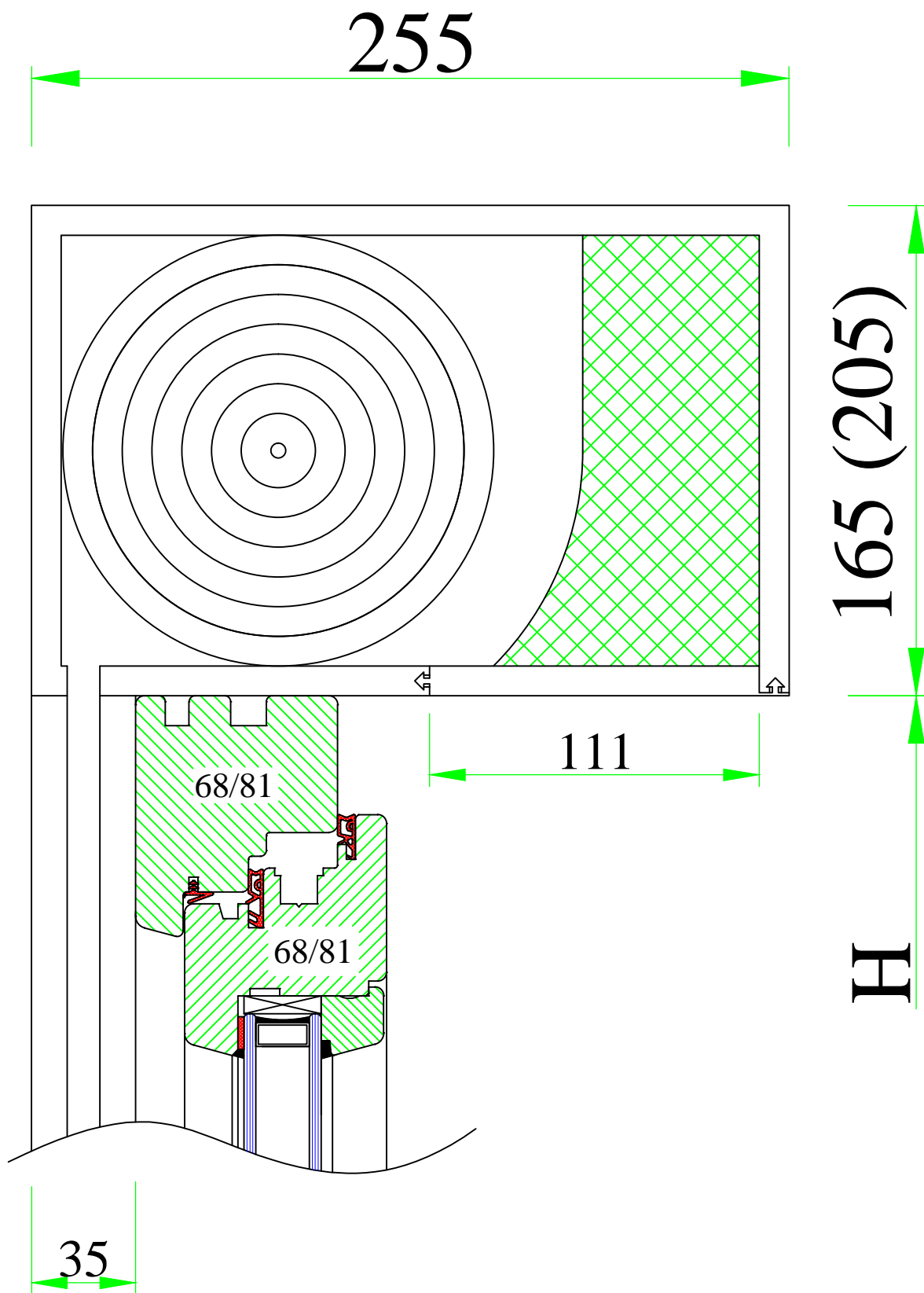

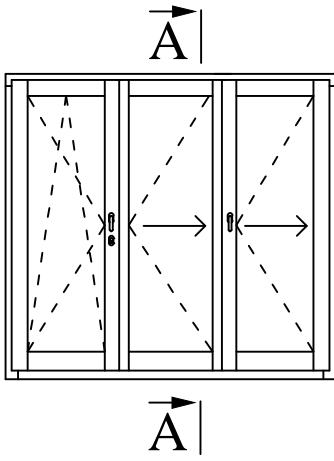

# A-A

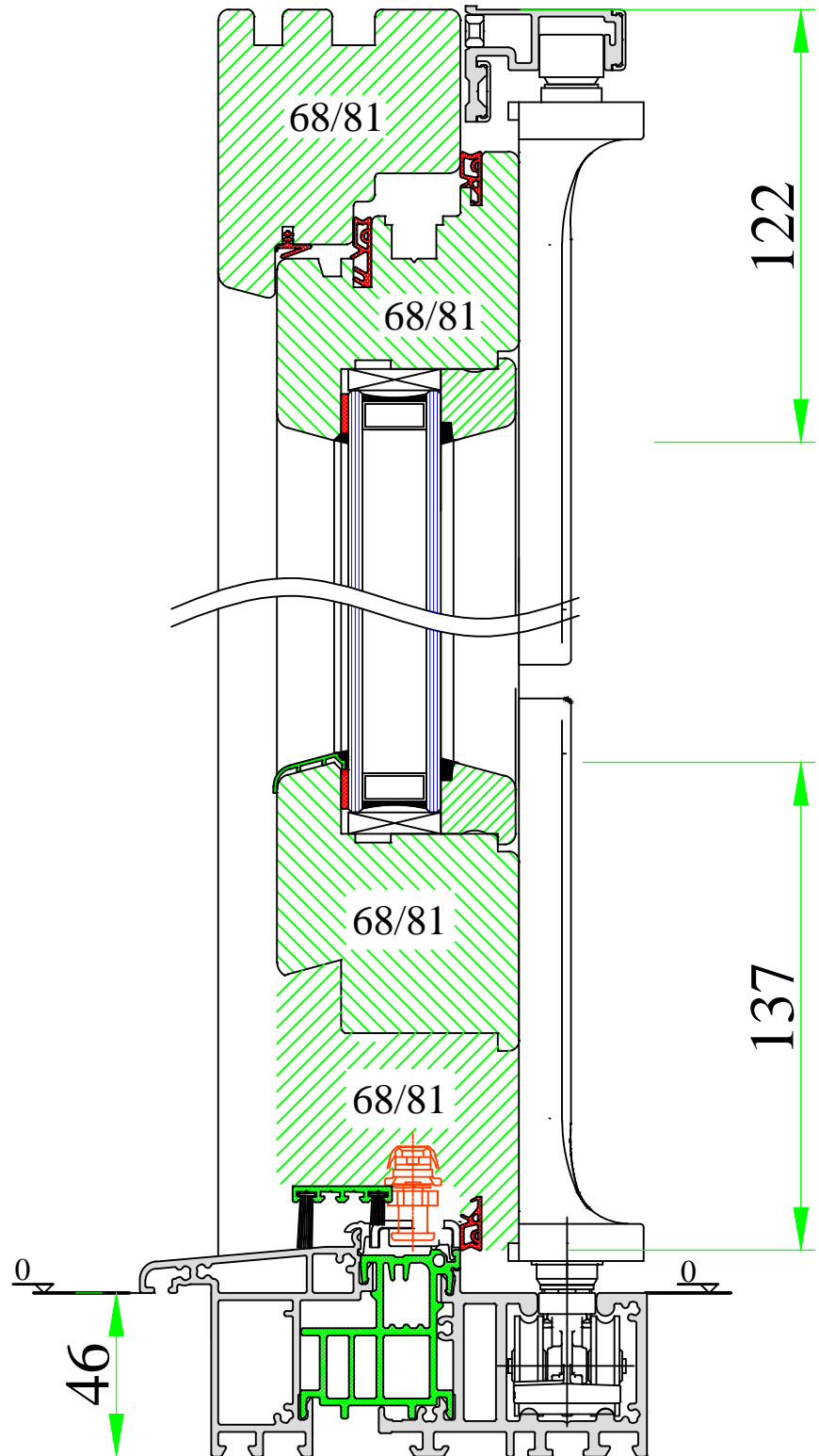

www.uniwin.co.uk



**UNI WINDOWS Ltd.**  
Unit 6, Edgefield Industrial Est.  
Loanhead, EH20 9TB  
Tel.: 0131 448 3931

IV 68 NEWLINE  
Folding sliding doors – aluminium  
threshold Comfort

Version:  
1  
Date:  
15.05.14

Scale:  
1:2  
Drawing:  
NON/11



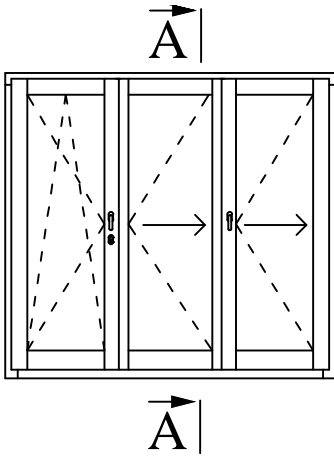

# A-A

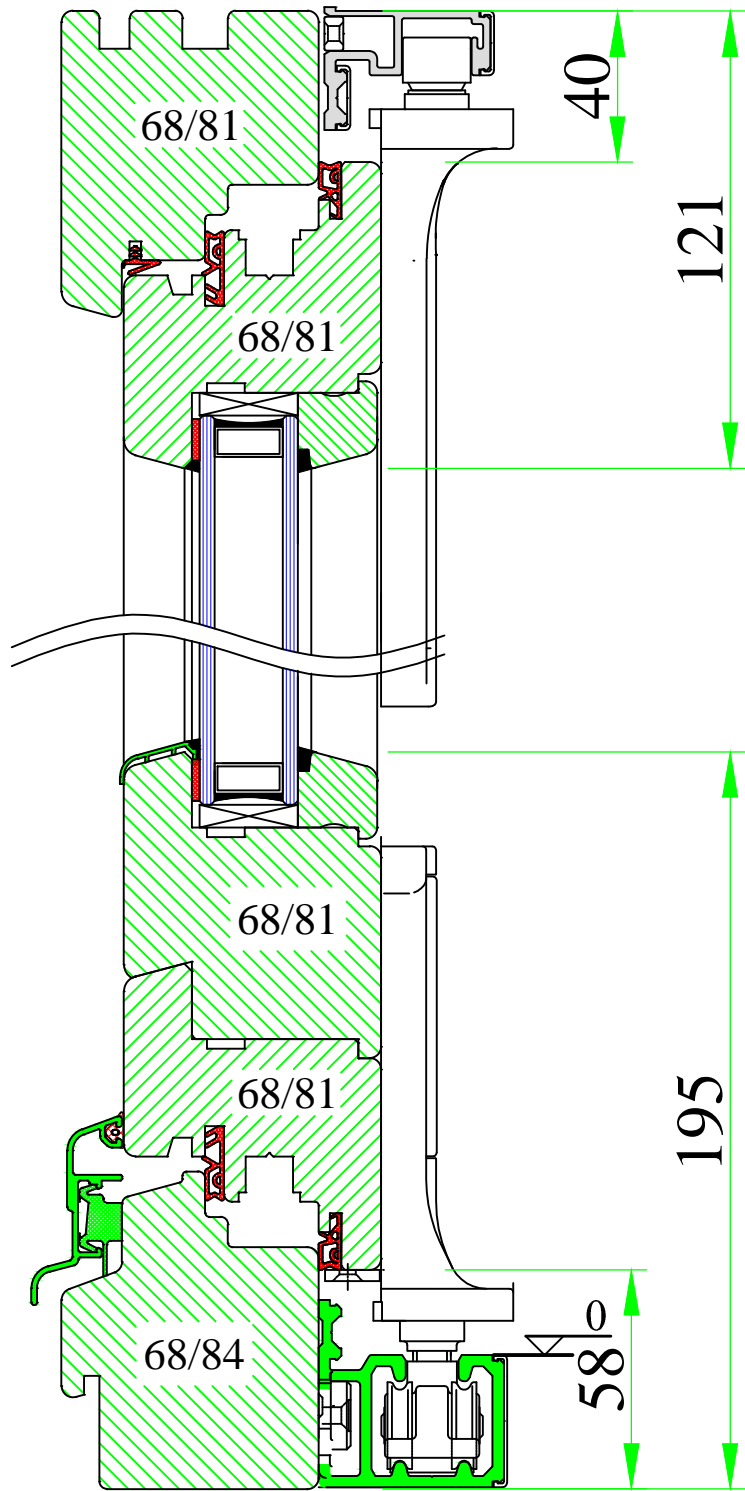

**UNI WINDOWS Ltd.**  
 Unit 6, Edgefield Industrial Est.  
 Loanhead, EH20 9TB  
 Tel.: 0131 448 3931

**IV 68 NEWLINE**  
 Folding sliding doors – wooden threshold

Version: 1	Scale: 1:2
Date: 15.05.14	Drawing: NON/11

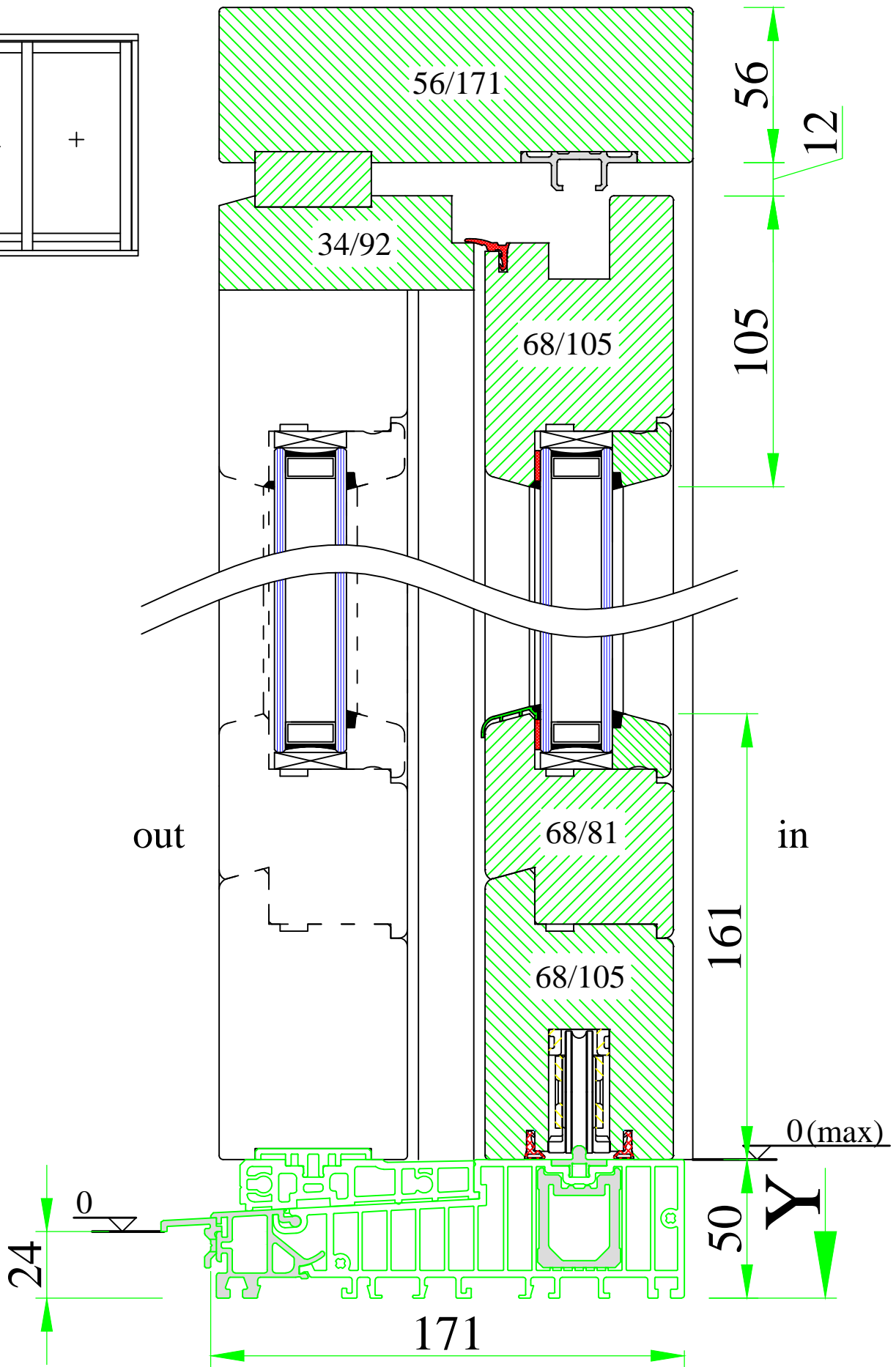
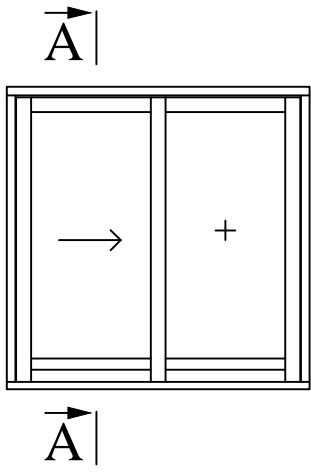

www.uniwin.co.uk



**UNI WINDOWS Ltd.**  
 Unit 6, Edgefield Industrial Est.  
 Loanhead, EH20 9TB  
 Tel.: 0131 448 3931

**IV 68 NEWLINE**  
 Lift and slide patio door – vertical cut

Version: 1	Scale: 1:2
Date: 15.05.14	Drawing: NNHS1

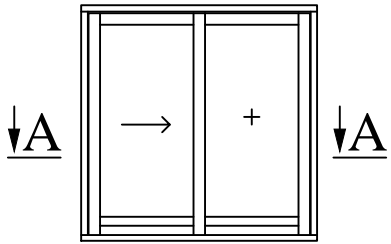

# A-A

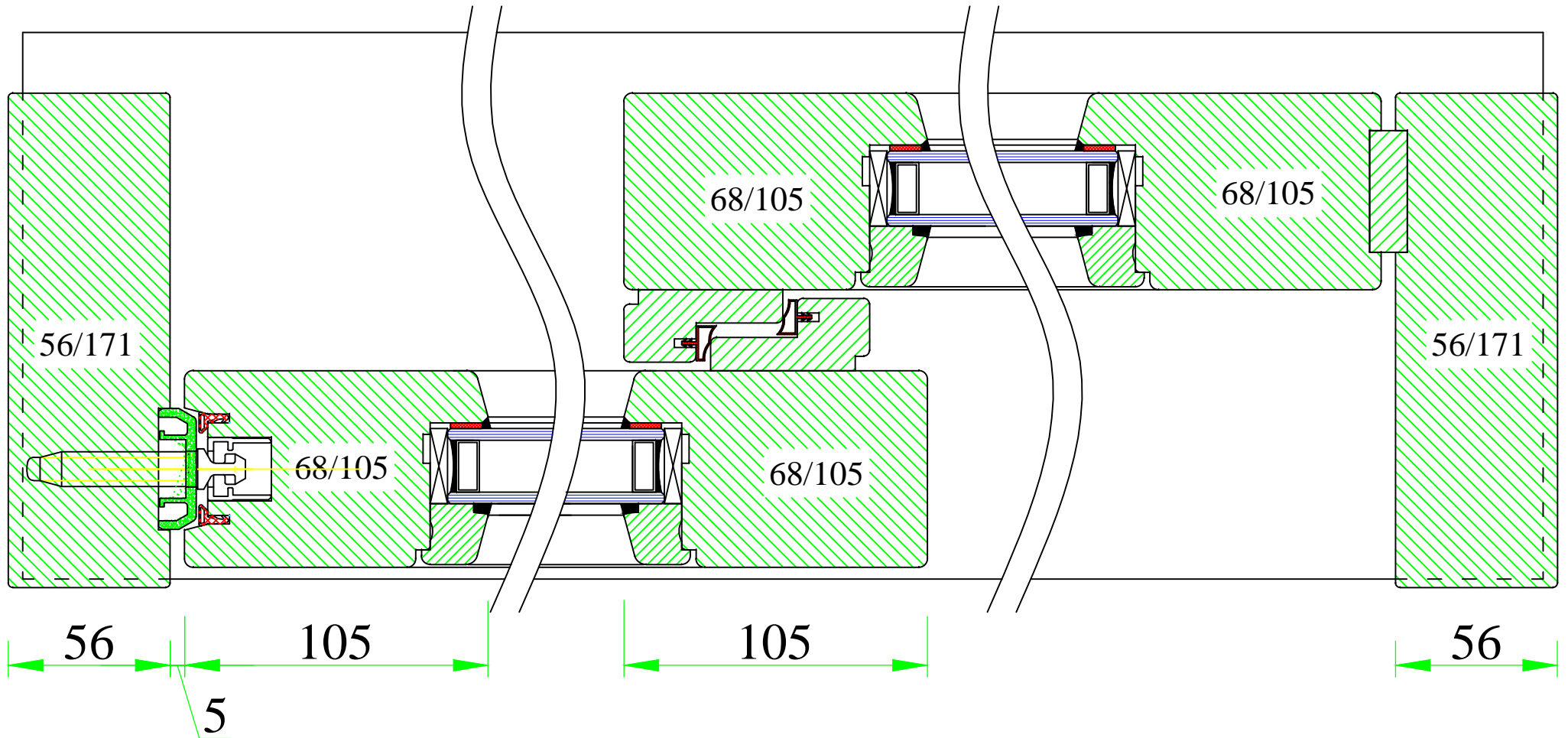

www.uniwin.co.uk



**UNI WINDOWS Ltd.**  
 Unit 6, Edgefield Industrial Est.  
 Loanhead, EH20 9TB  
 Tel.: 0131 448 3931

IV 68 NEWLINE  
 Lift and slide patio door – horizontal cut

Version: 1	Scale: 1:9
Date: 15.05.14	Drawing: NNHS/2

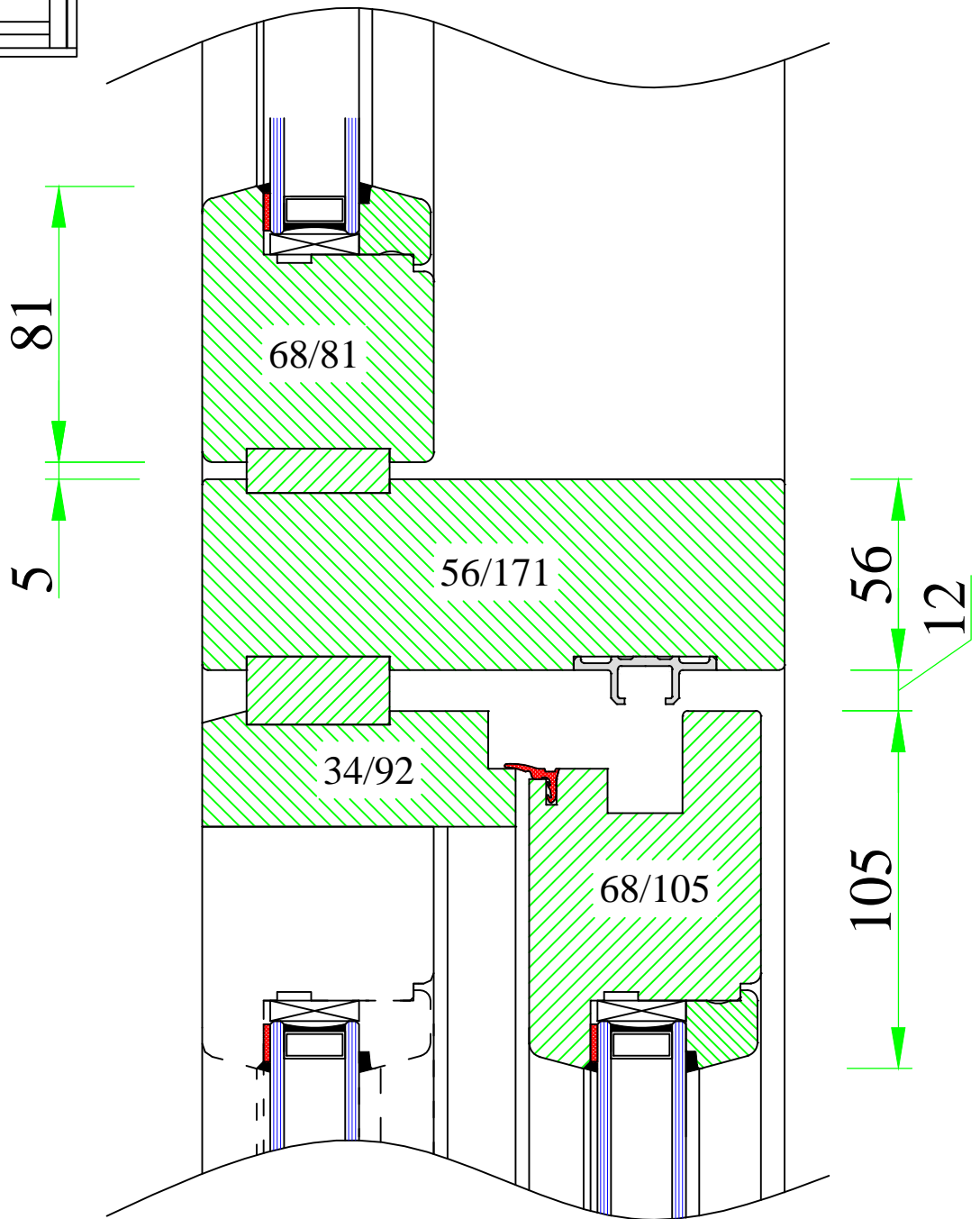
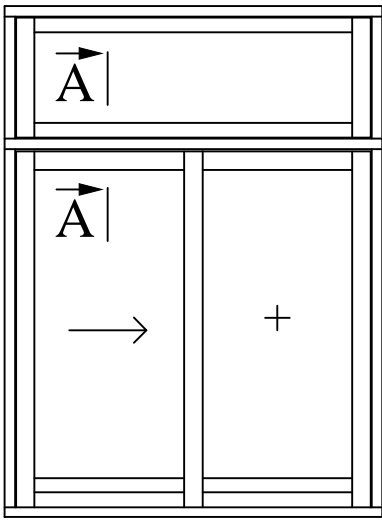

**UNI WINDOWS Ltd.**  
 Unit 6, Edgefield Industrial Est.  
 Loanhead, EH20 9TB  
 Tel.: 0131 448 3931

**IV 68 NEWLINE**  
 Lift & slide portal door with fixed top light

Version:  
1  
 Date:  
15.05.14

Scale:  
1:2  
 Drawing:  
NNHS/3

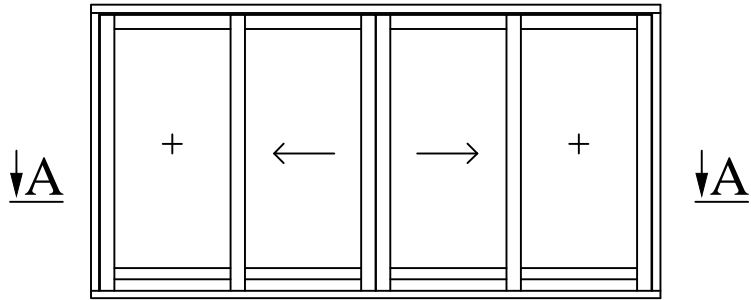

# A-A

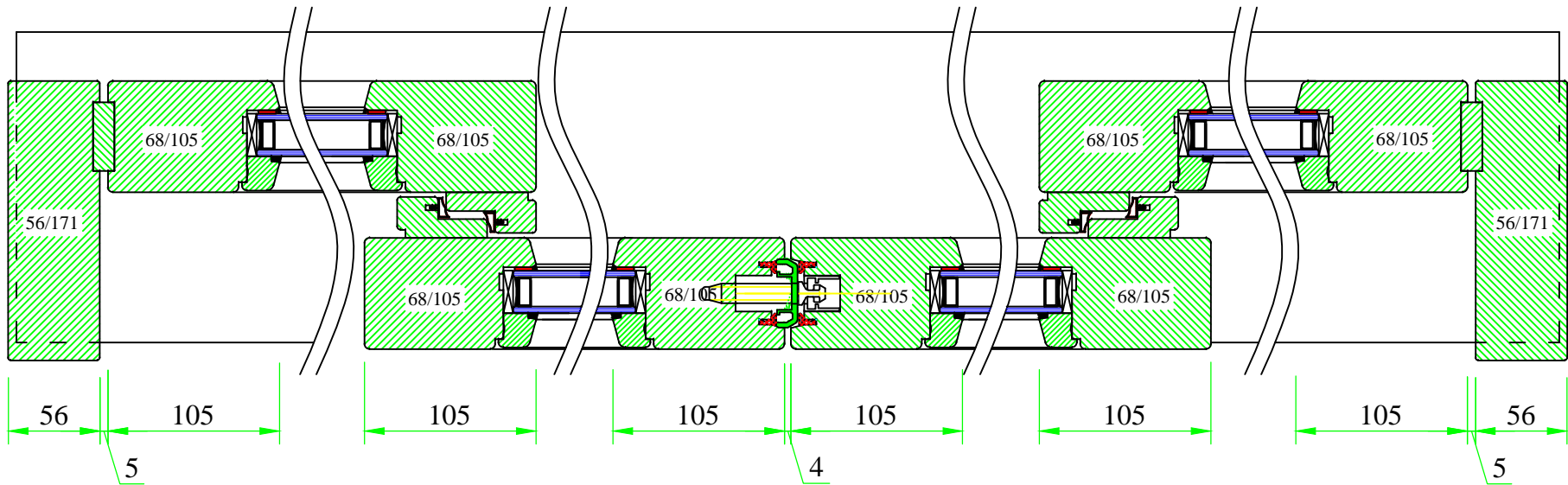

**UNI WINDOWS Ltd.**  
 Unit 6, Edgefield Industrial Est.  
 Loanhead, EH20 9TB  
 Tel.: 0131 448 3931

IV 68 NEWLINE  
 Lift & slide portal door – horizontal cut  
 – C type

Version: 1	Scale: 1:4
Date: 15.05.14	Drawing: NNHS4

A

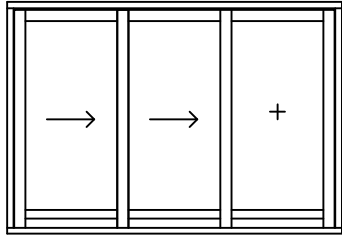

A

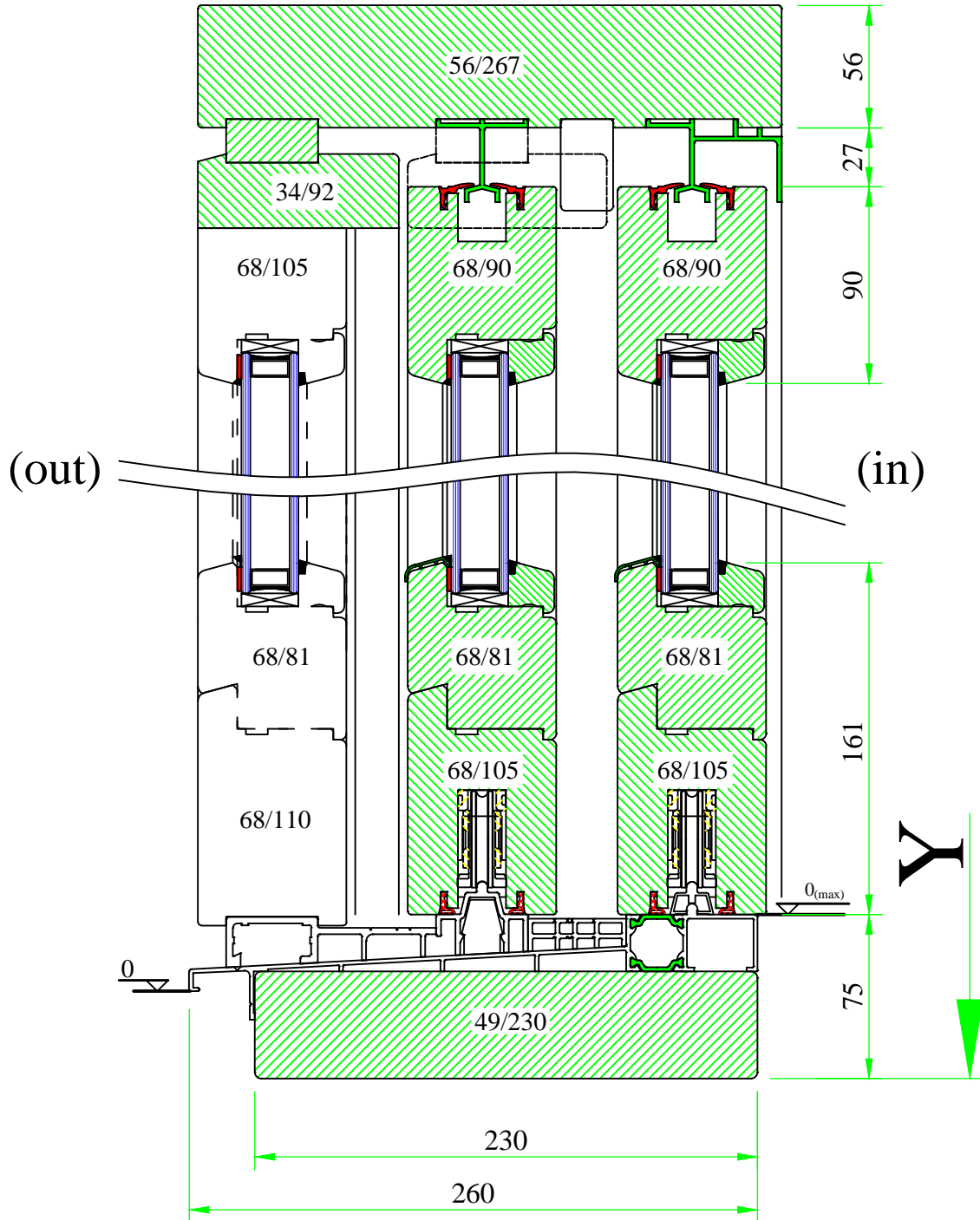

www.uniwin.co.uk



**UNI WINDOWS Ltd.**  
 Unit 6, Edgefield Industrial Est.  
 Loanhead, EH20 9TB  
 Tel.: 0131 448 3931

IV 68 NEWLINE

Lift & slide door – vertical cut – type E

Version:  
1

Scale:  
1:3

Date:  
15.05.14

Drawing:  
NNHS5

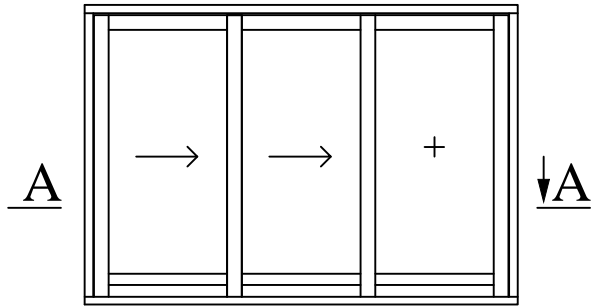

# A-A

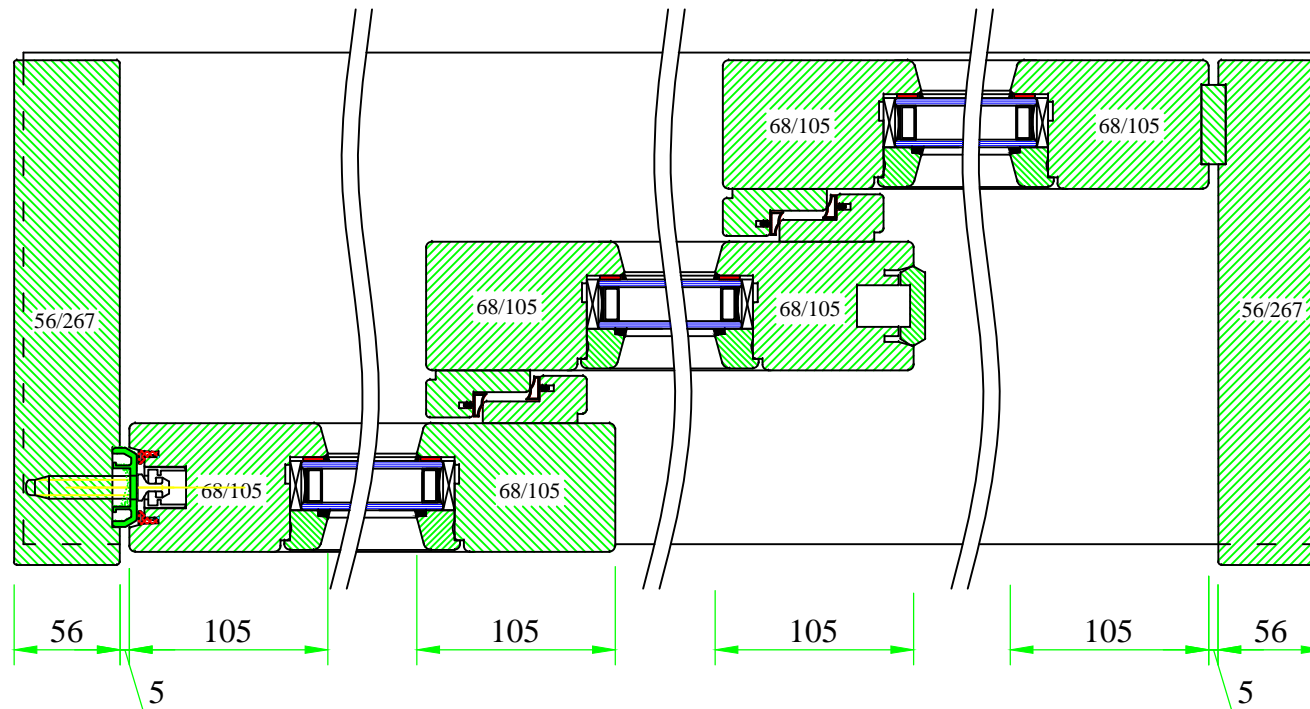

**UNI WINDOWS Ltd.**  
 Unit 6, Edgefield Industrial Est.  
 Loanhead, EH20 9TB  
 Tel.: 0131 448 3931

IV 68 NEWLINE  
 Lift & slide portal door – horizontal cut –  
 type E

Version: 1	Scale: 1:4
Date: 15.05.14	Drawing: NNHS6

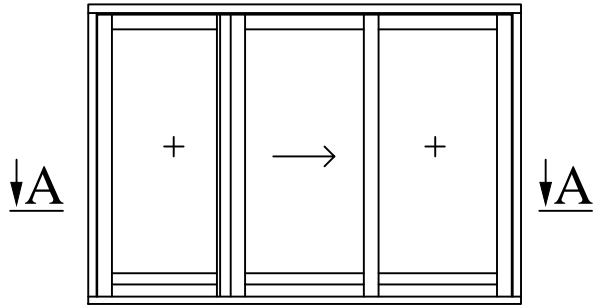

# A-A

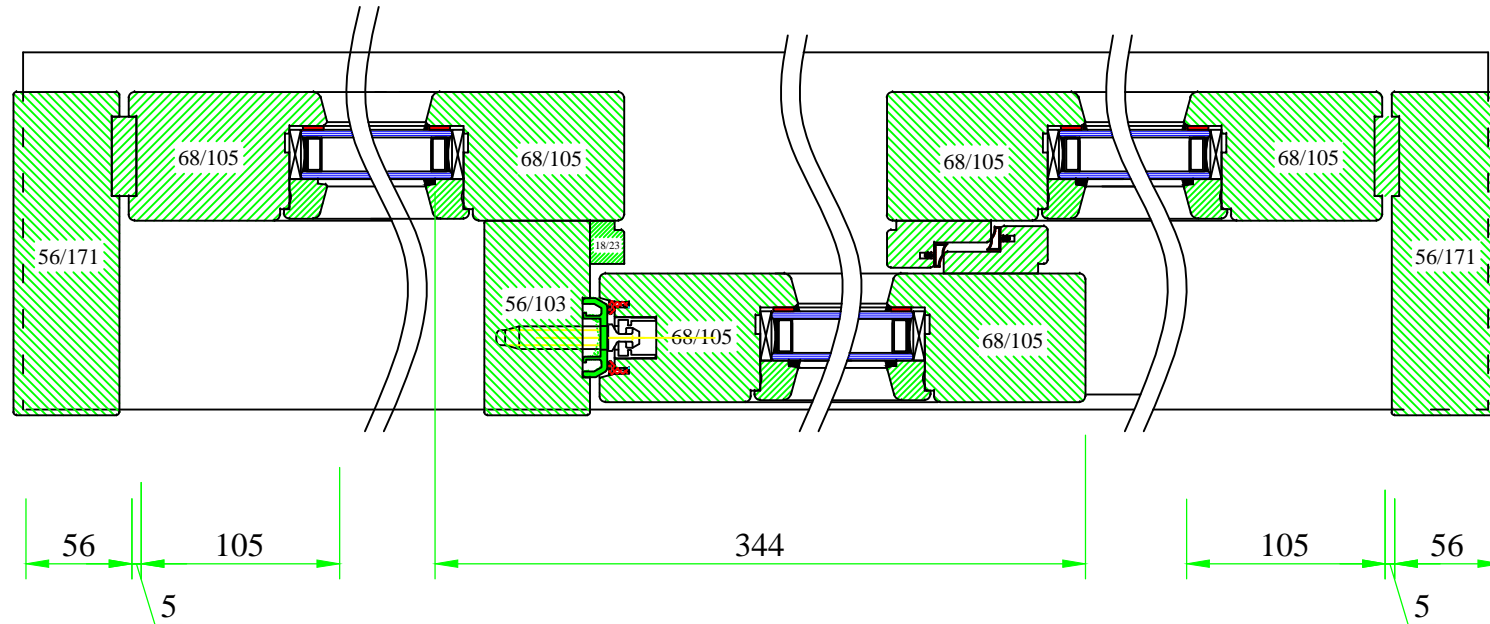

**UNI WINDOWS Ltd.**  
 Unit 6, Edgefield Industrial Est.  
 Loanhead, EH20 9TB  
 Tel.: 0131 448 3931

**IV 68 NEWLINE**  
 Lift & slide portal door – horizontal cut –  
 type E

Version: 1	Scale: 1:4
Date: 15.05.14	Drawing: NNHS7



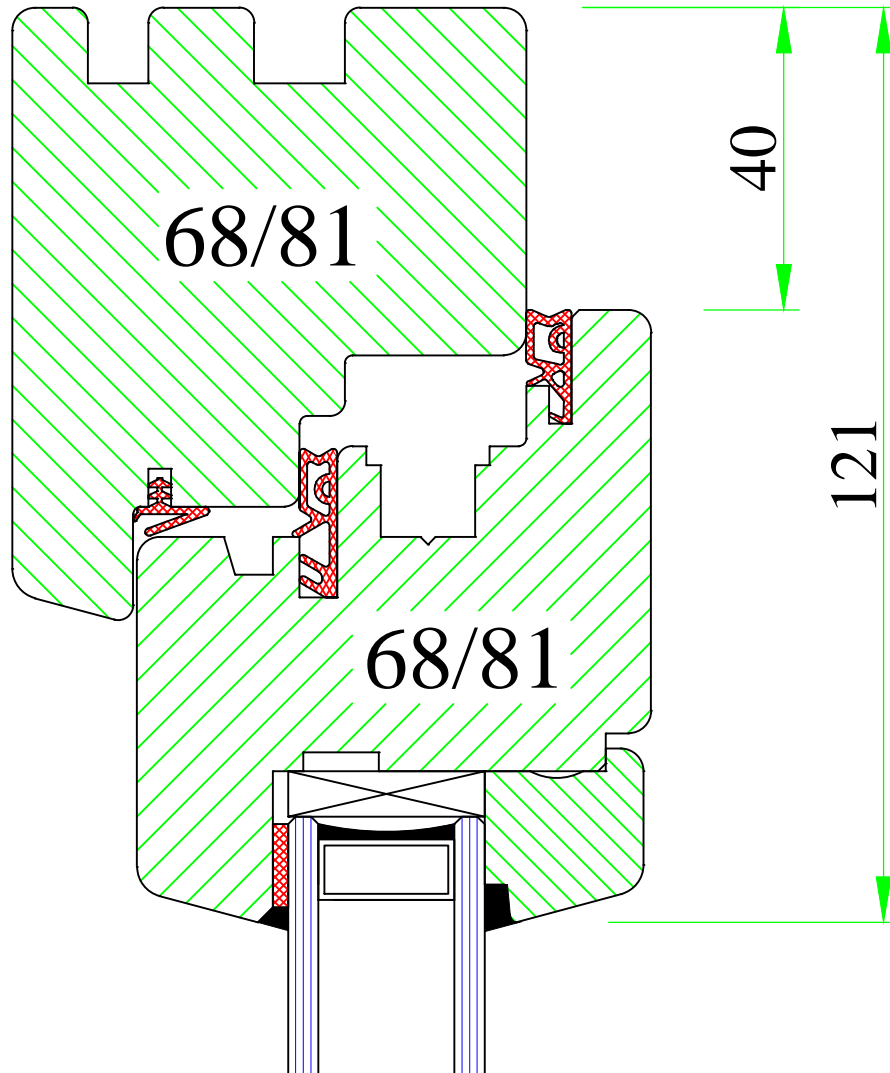
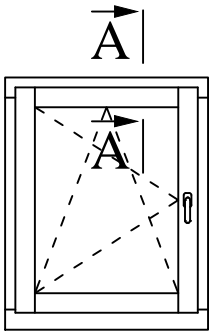

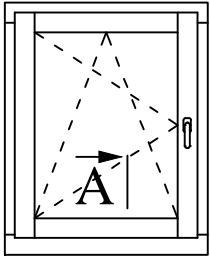

A

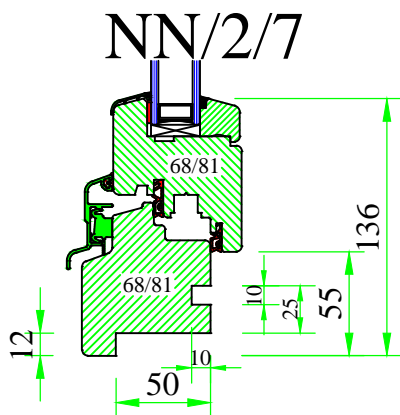
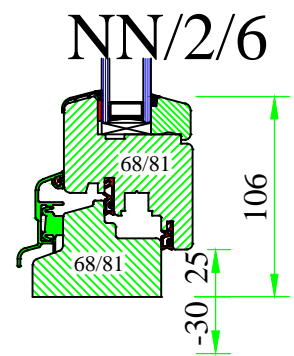
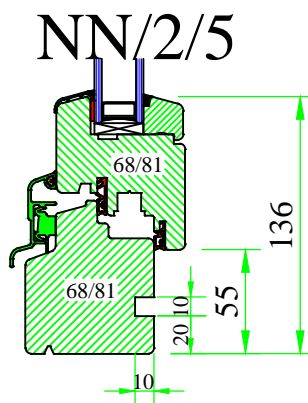
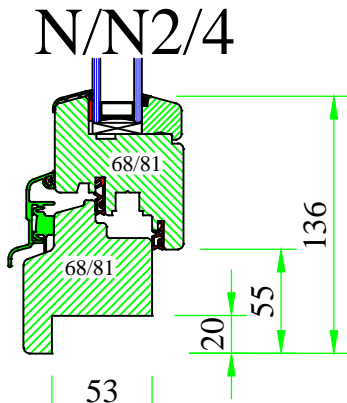
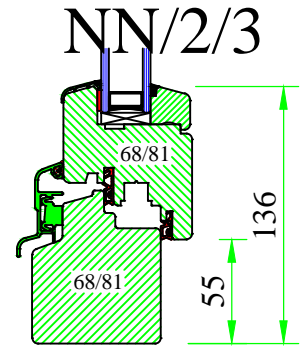
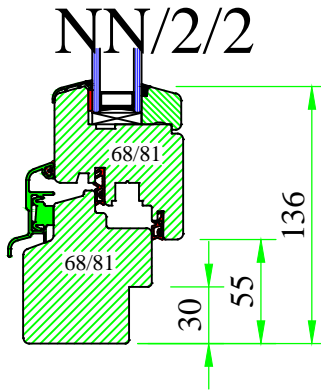
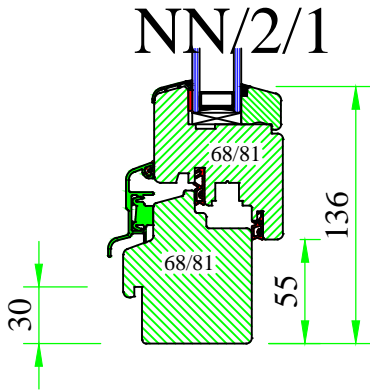
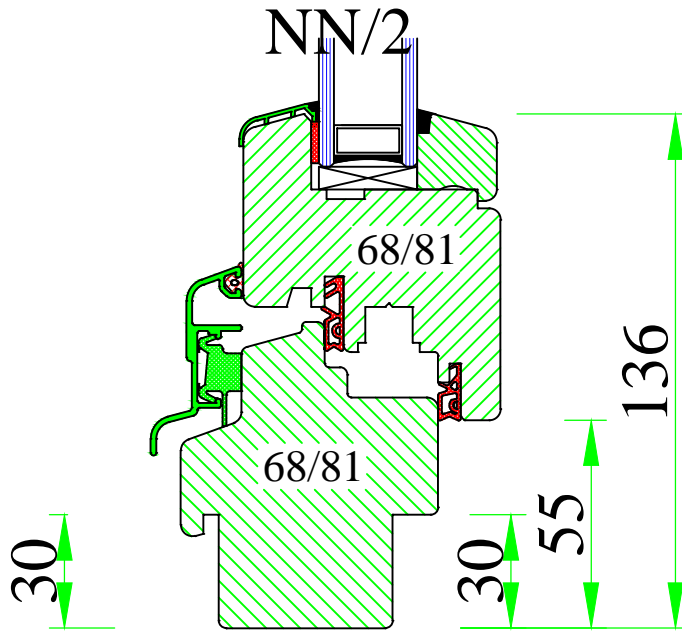

**UNI WINDOWS Ltd.**  
 Unit 6, Edgefield Industrial Est.  
 Loanhead, EH20 9TB  
 Tel.: 0131 448 3931

IV 68 NEWLINE  
 Frame-sash connection – bottom

Version: 1	Scale: 1:4
Date: 15.05.14	Drawing: NN/2

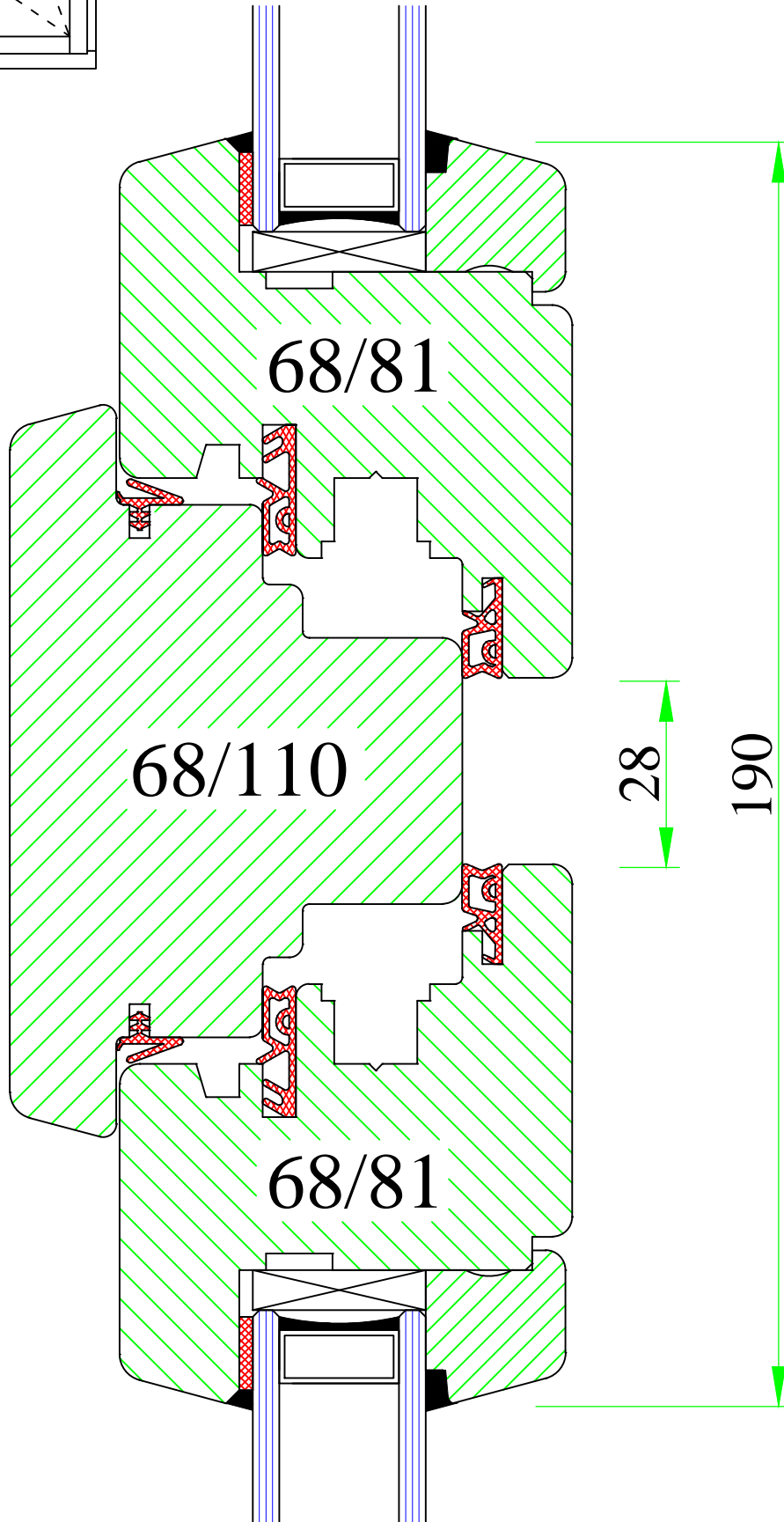
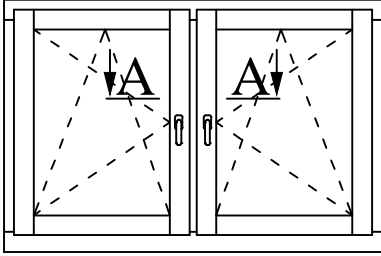

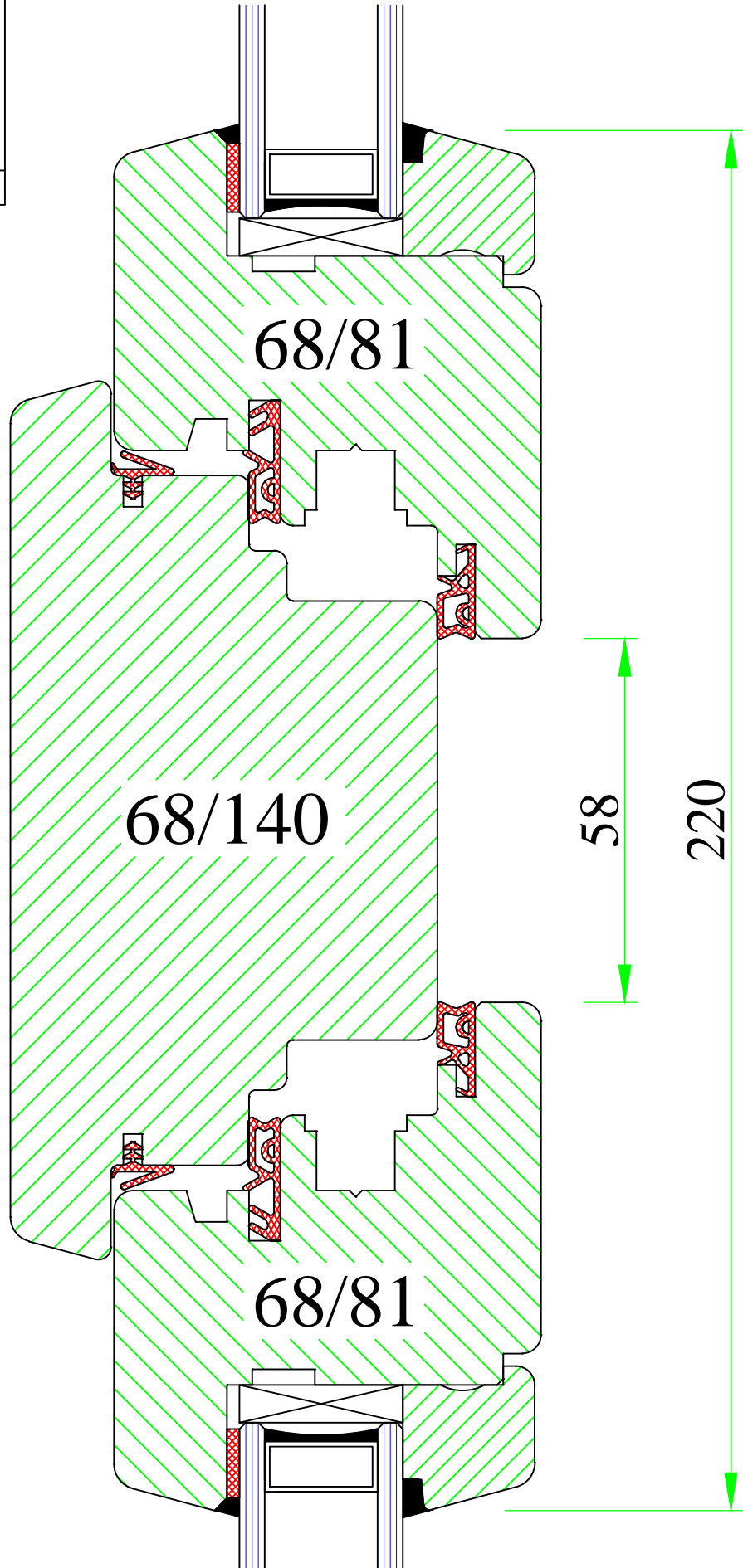
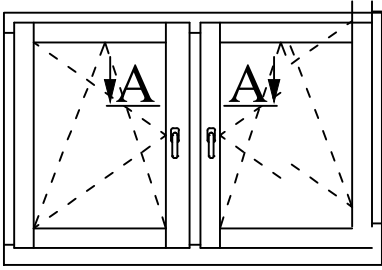

www.uniwin.co.uk



**UNI WINDOWS Ltd.**  
 Unit 6, Edgefield Industrial Est.  
 Loanhead, EH20 9TB  
 Tel.: 0131 448 3931

IV 68 NEWLINE

Double opening window fixed mullion 140mm

Version:  
1

Scale:  
1:1

Date:  
15.05.14

Drawing:  
NN/4

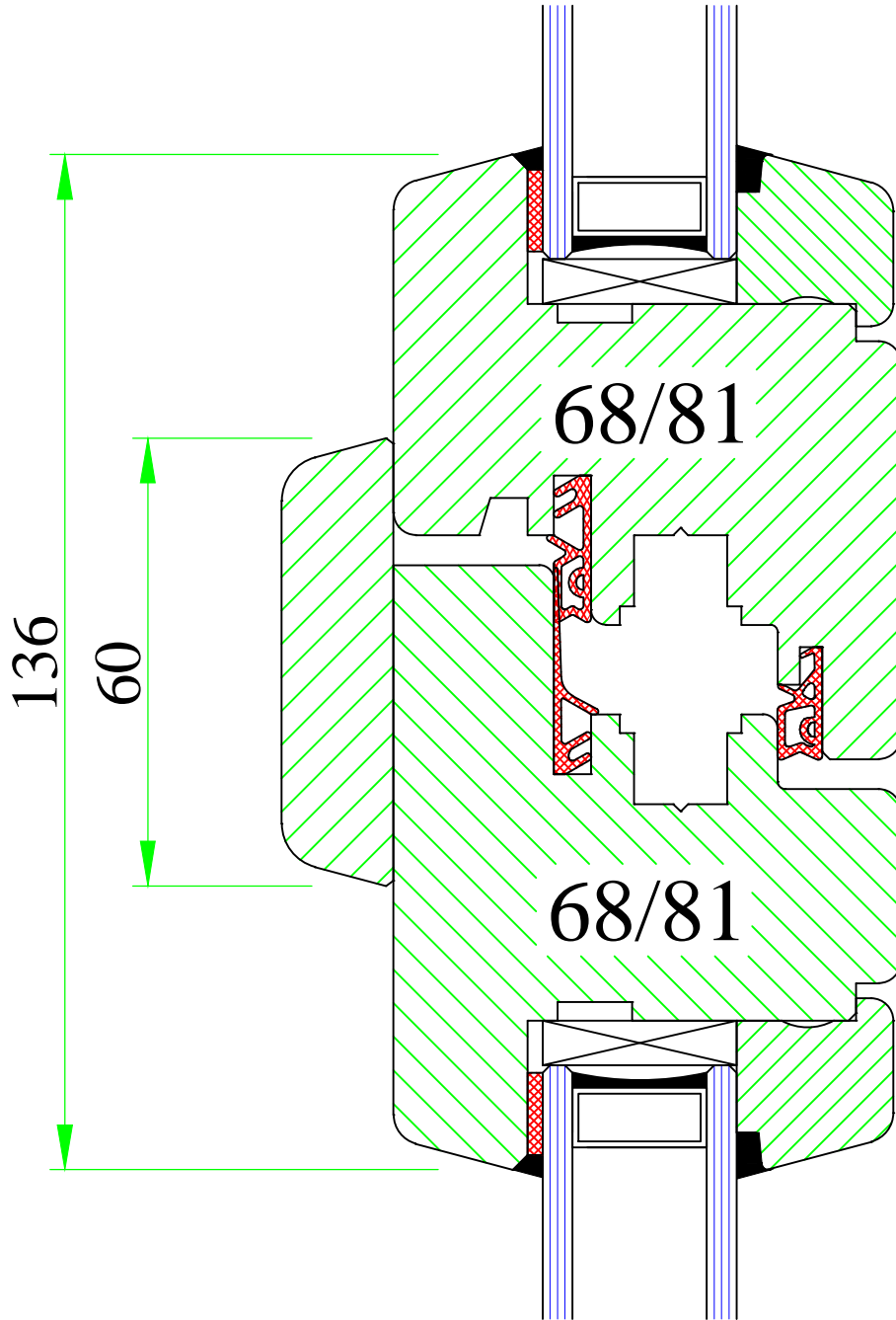
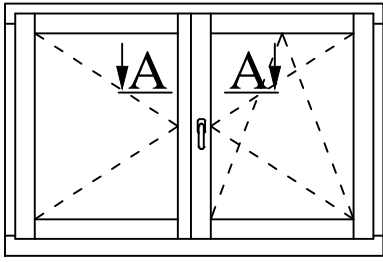

**UNI WINDOWS Ltd.**  
 Unit 6, Edgefield Industrial Est.  
 Loanhead, EH20 9TB  
 Tel.: 0131 448 3931

"Flying" mullion

IV 68 NEWLINE

Version:  
1

Scale:  
1:1

Date:  
15.05.14

Drawing:  
NN/5

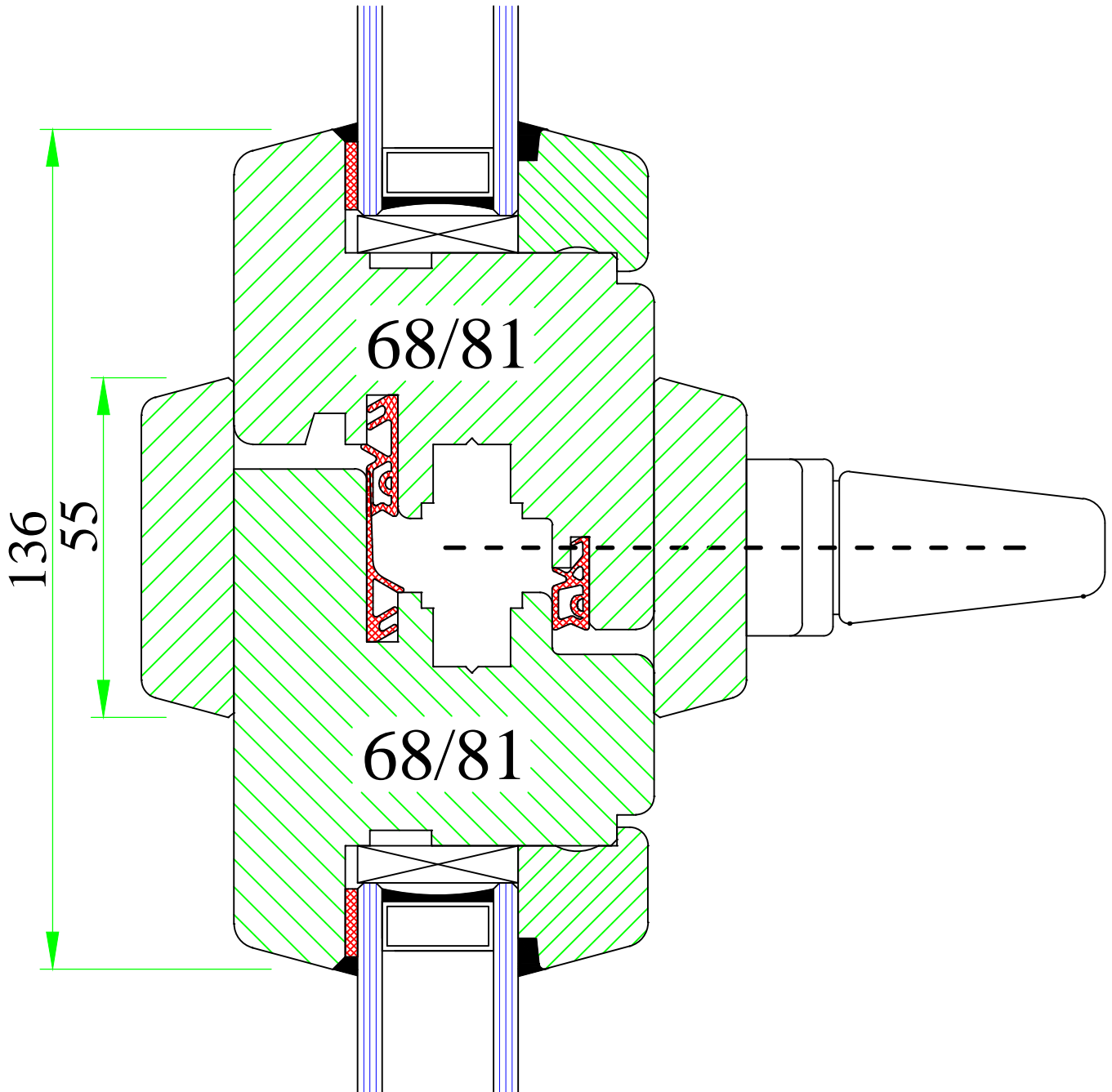
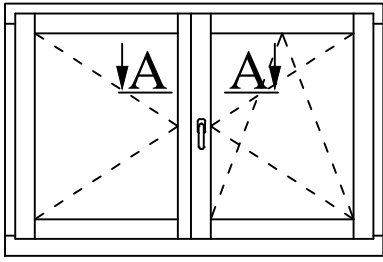

**UNI WINDOWS Ltd.**  
 Unit 6, Edgefield Industrial Est.  
 Loanhead, EH20 9TB  
 Tel.: 0131 448 3931

IV 68 NEWLINE

"Flying" mullion – handle with timber extension

Version:  
1

Date:  
15.05.14

Scale:  
1:1

Drawing:  
NN/5-1

A

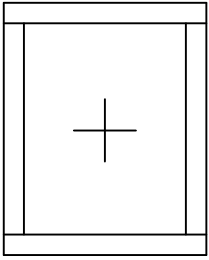

A

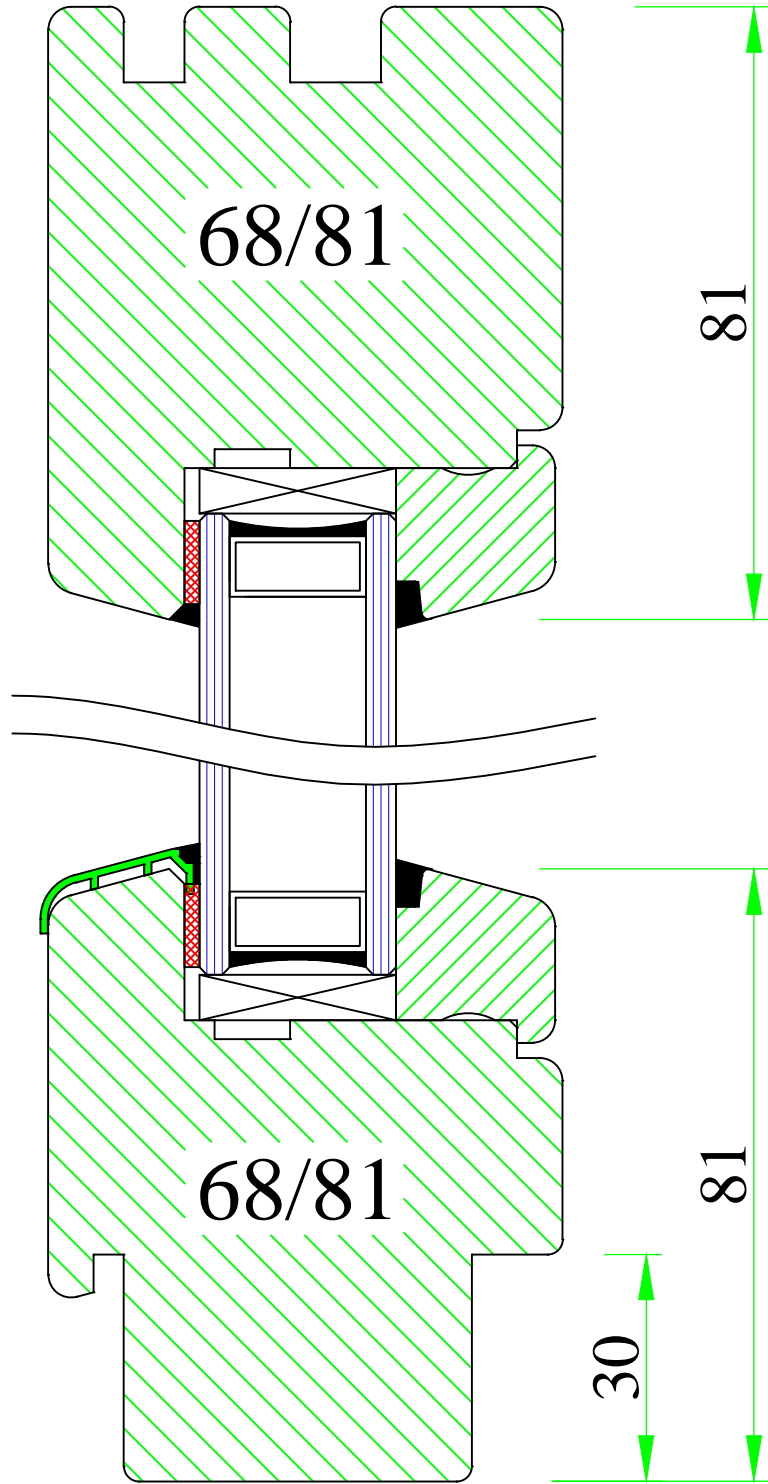

**UNI WINDOWS Ltd.**  
Unit 6, Edgefield Industrial Est.  
Loanhead, EH20 9TB  
Tel.: 0131 448 3931

Fixed glazing

IV 68 NEWLINE

Version:  
1

Scale:  
1:1

Date:  
15.05.14

Drawing:  
NN/6

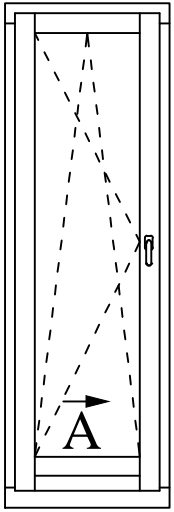

A

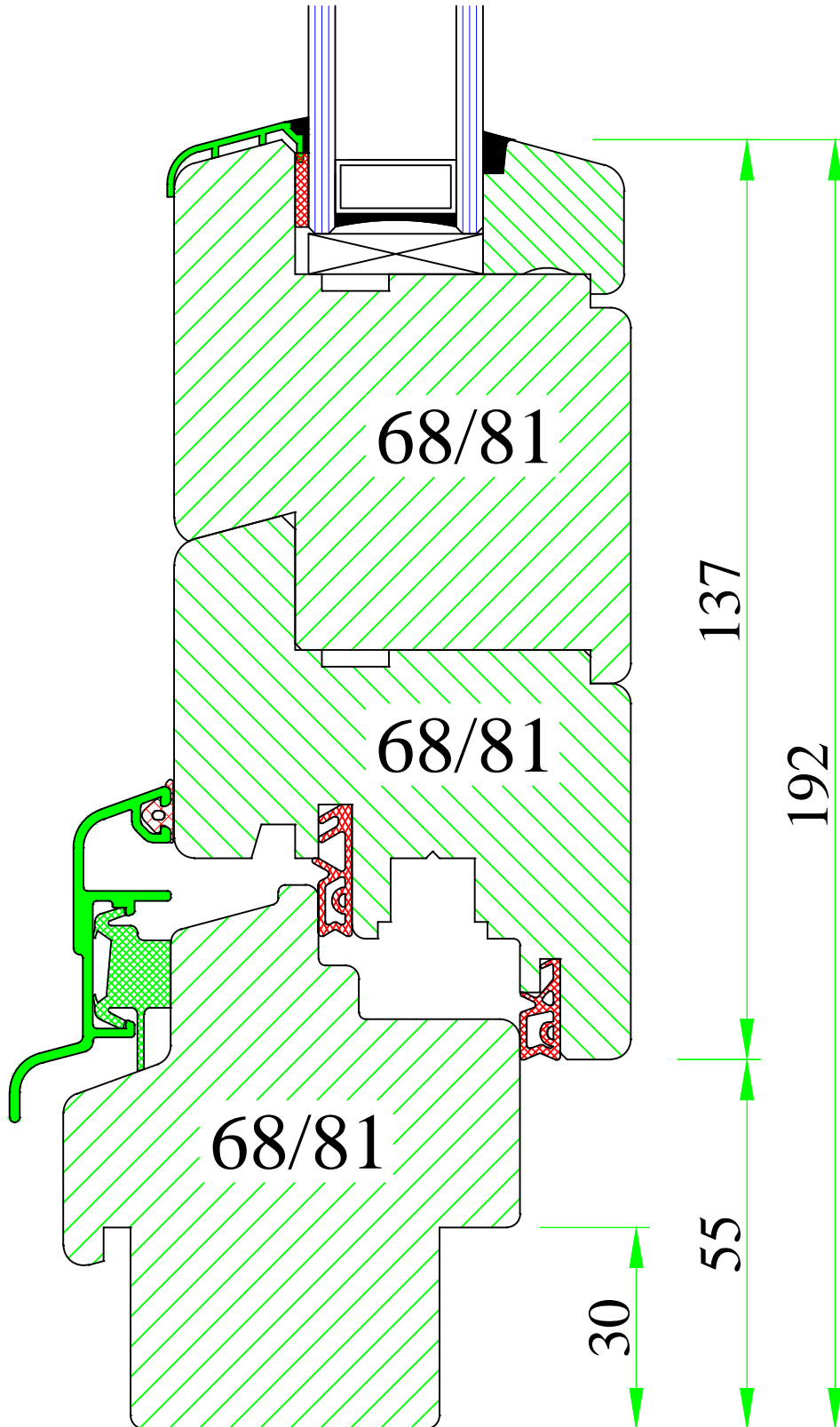



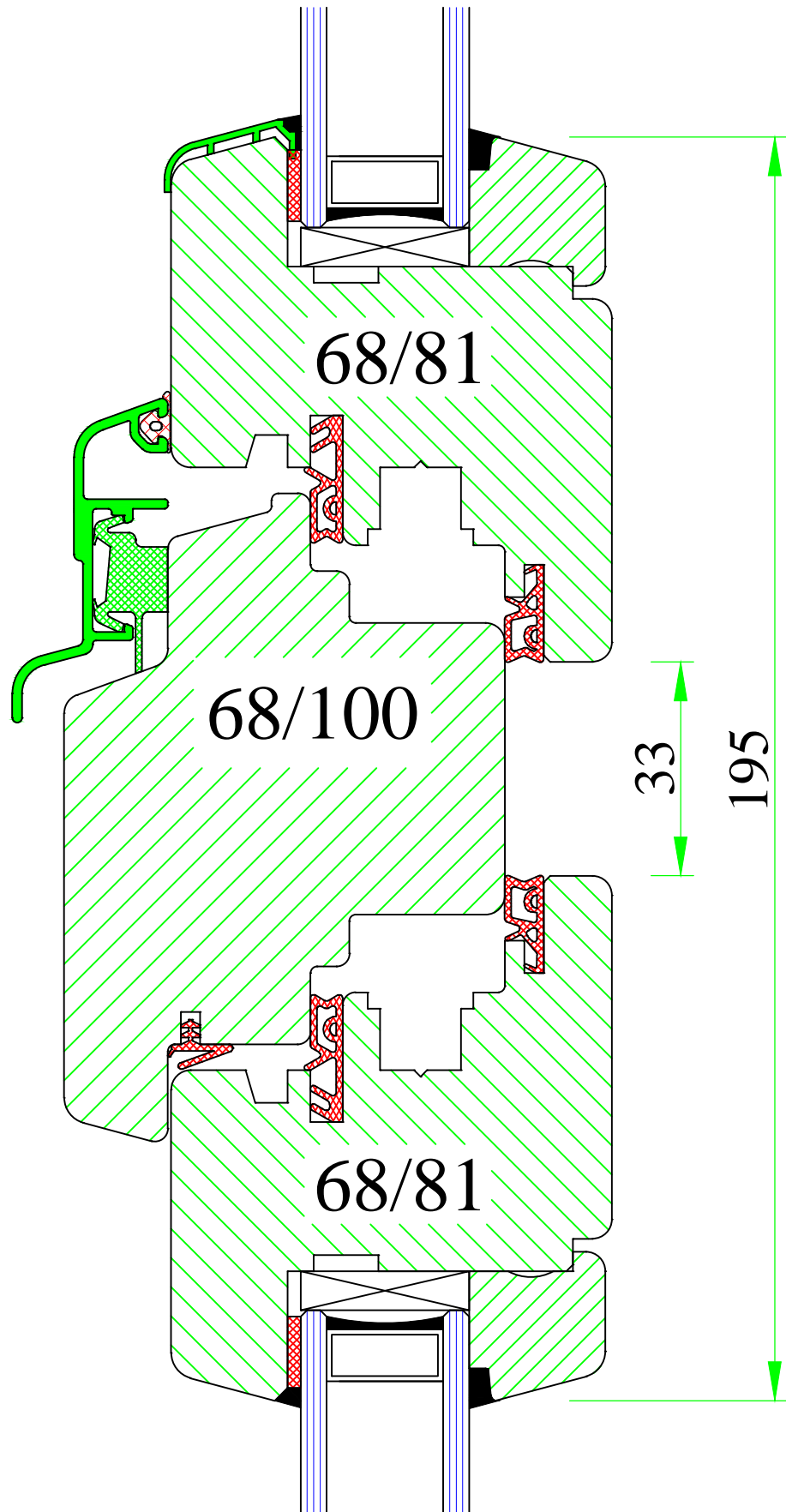
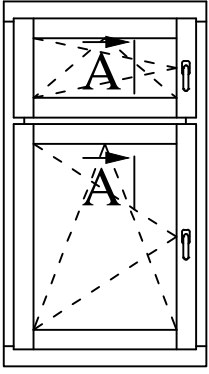

www.uniwin.co.uk



**UNI WINDOWS Ltd.**  
 Unit 6, Edgefield Industrial Est.  
 Loanhead, EH20 9TB  
 Tel.: 0131 448 3931

IV 68 NEWLINE

Bottom and top sash – transom 81mm

Version:  
1

Scale:  
1:1

Date:  
15.05.14

Drawing:  
NN/8

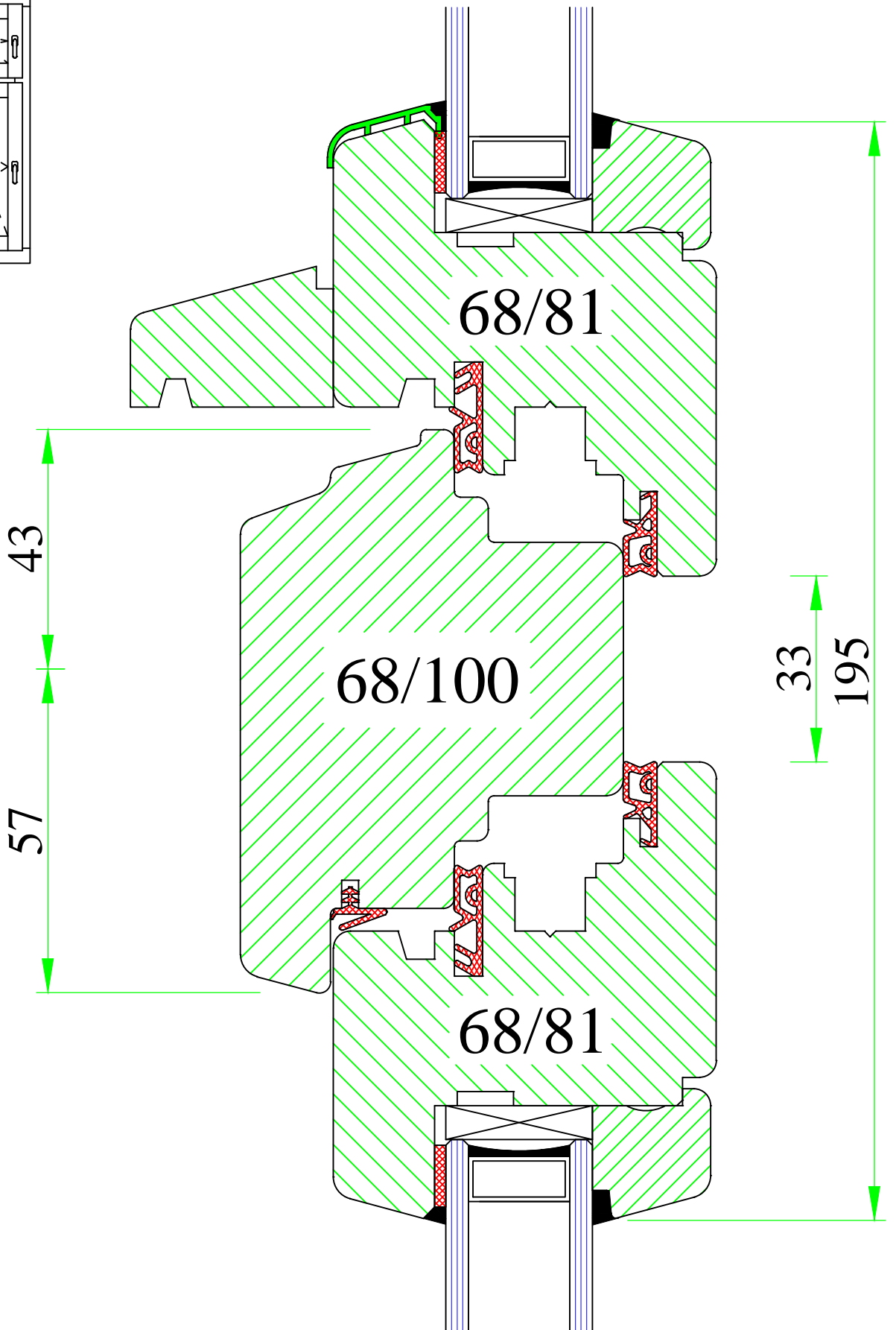
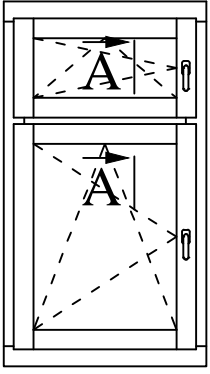

www.uniwin.co.uk



**UNI WINDOWS Ltd.**  
 Unit 6, Edgefield Industrial Est.  
 Loanhead, EH20 9TB  
 Tel.: 0131 448 3931

IV 68 NEWLINE  
 Bottom and top sash – transom 81mm

Version: 1	Scale: 1:1
Date: 15.05.14	Drawing: NN/8-1

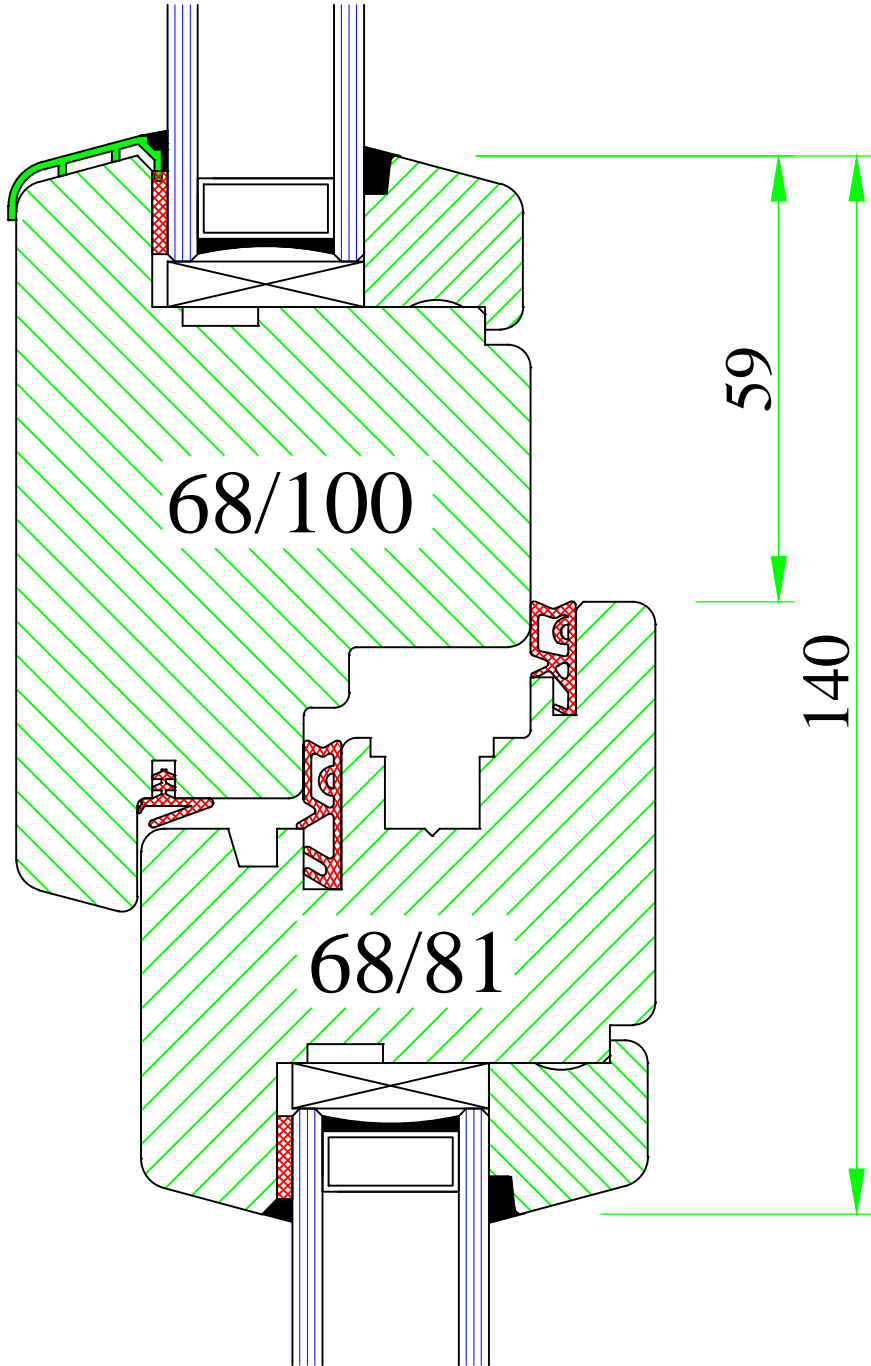
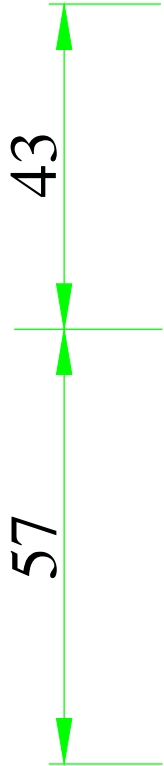
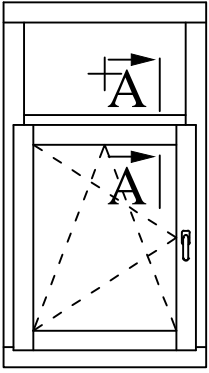

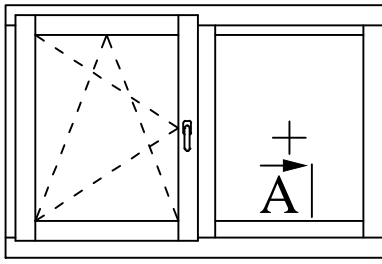

A

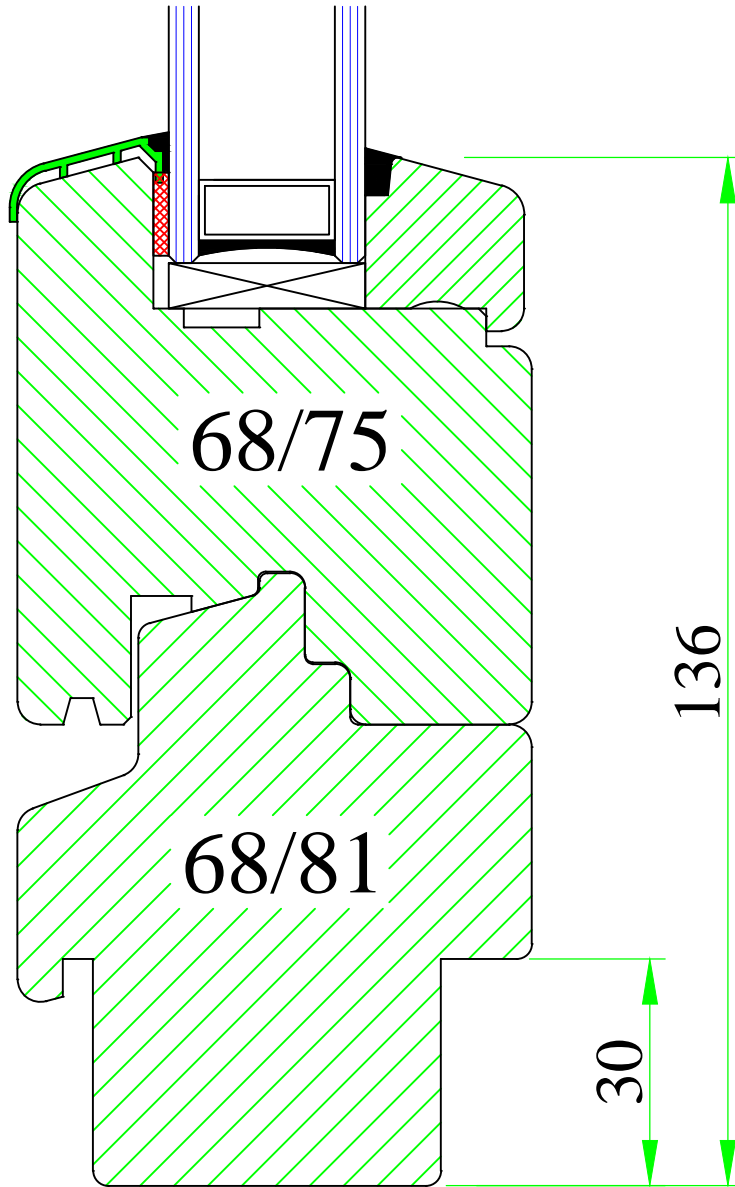

**UNI WINDOWS Ltd.**  
 Unit 6, Edgefield Industrial Est.  
 Loanhead, EH20 9TB  
 Tel.: 0131 448 3931

IV 68 NEWLINE  
 Glass line alignment window – bottom

Version:  
1  
 Date:  
15.05.14

Scale:  
1:1  
 Drawing:  
NN/10

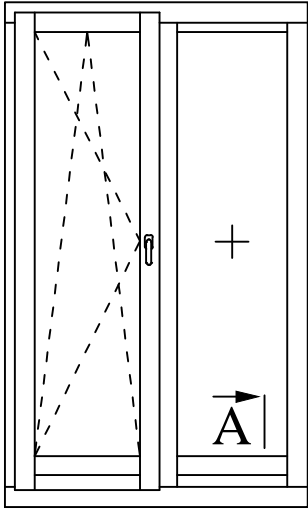

A

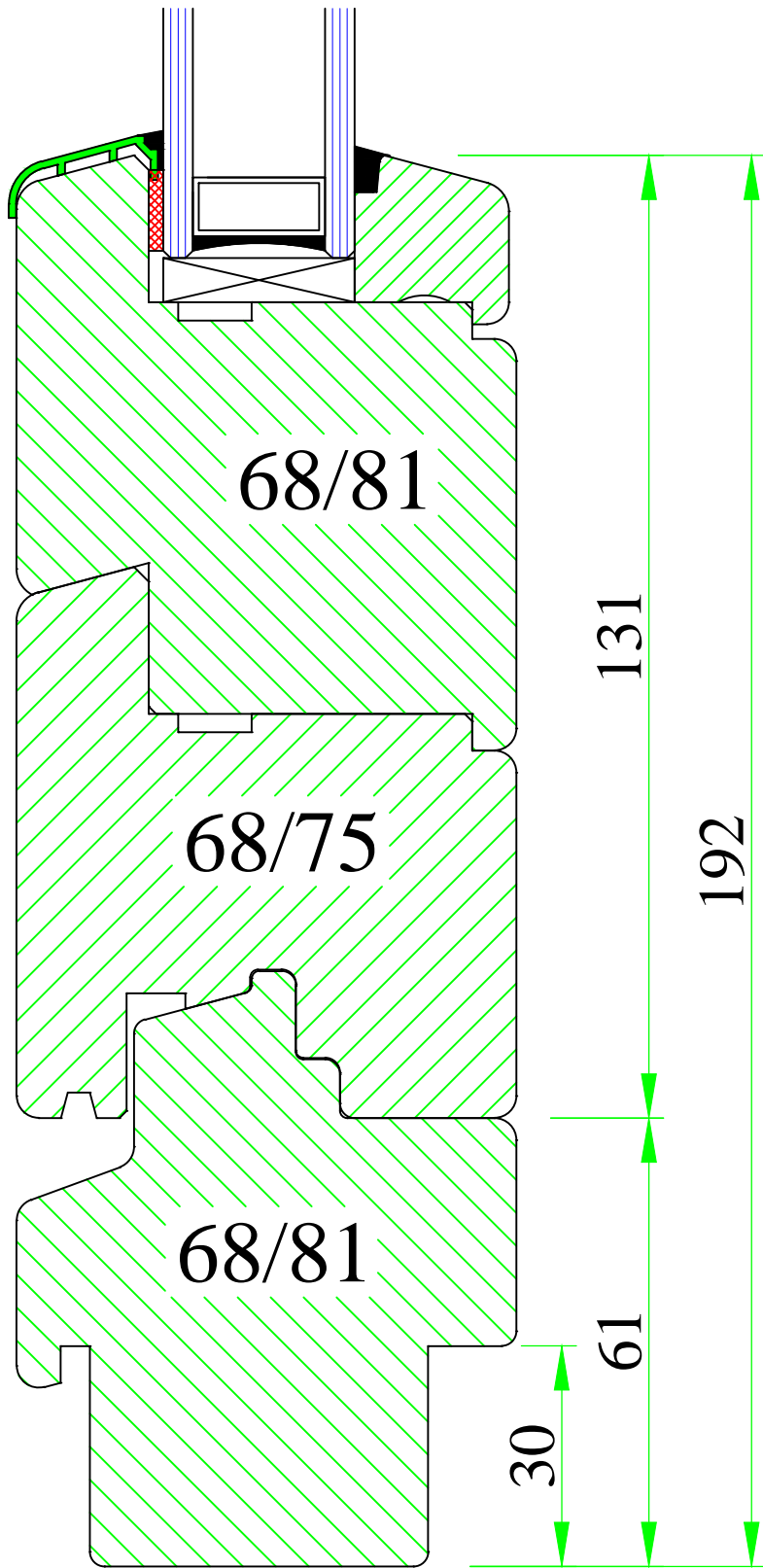

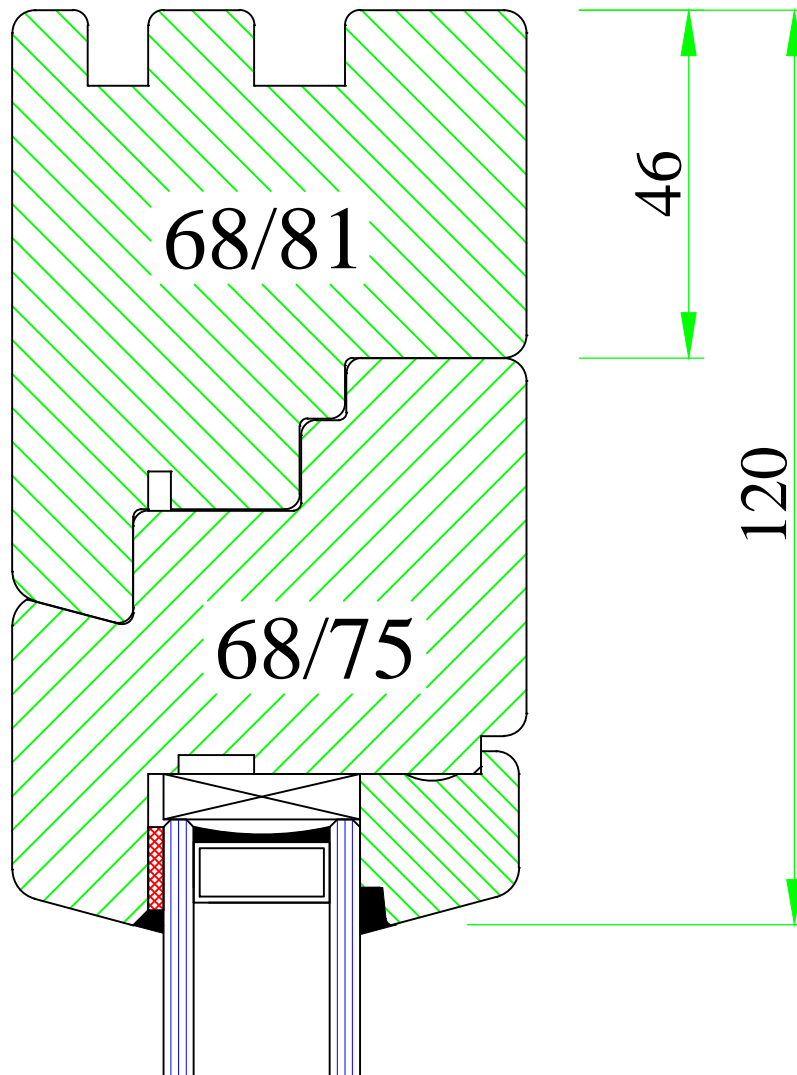
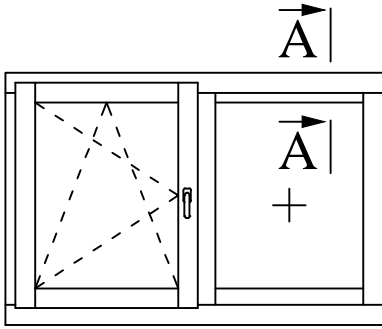

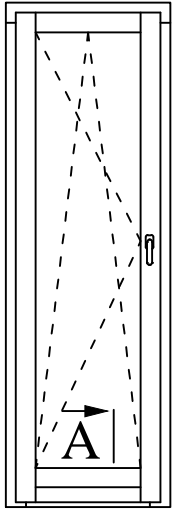

A

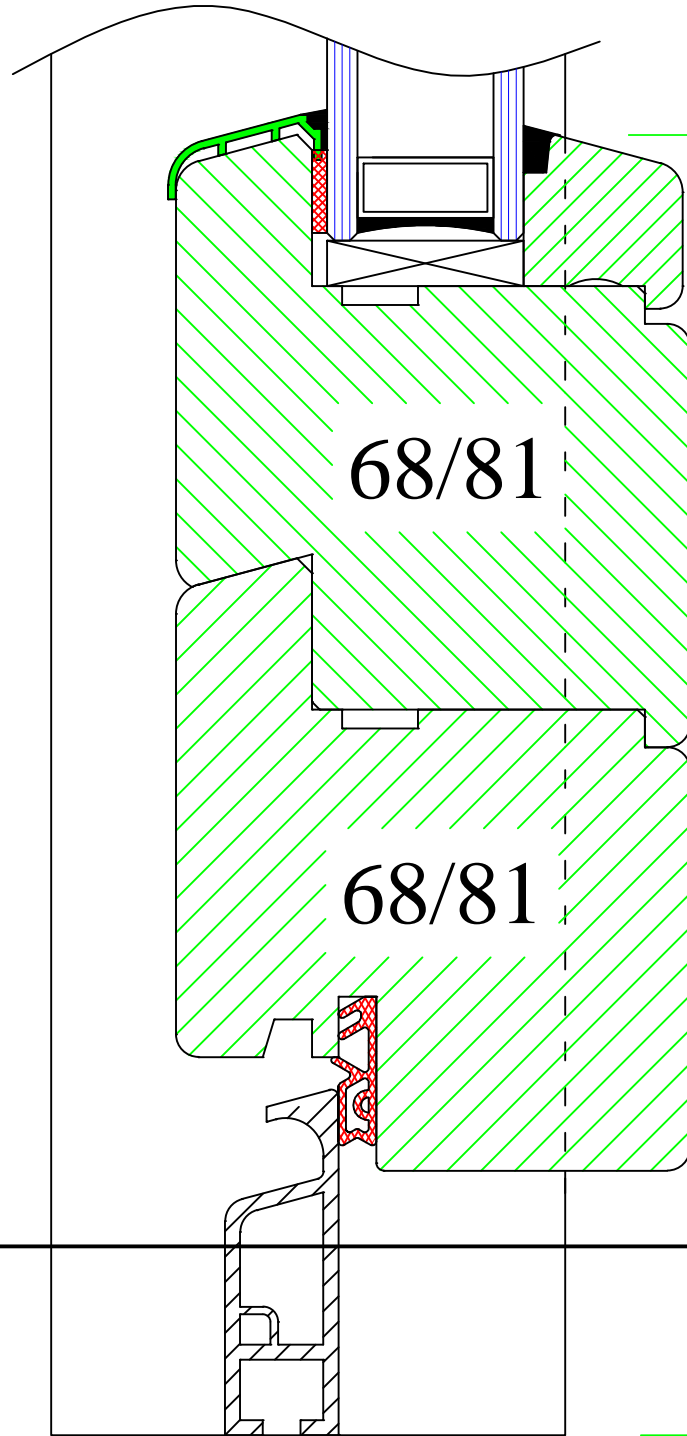

137

159

Y

O<sub>max</sub>

25

10



**UNI WINDOWS Ltd.**  
 Unit 6, Edgefield Industrial Est.  
 Loanhead, EH20 9TB  
 Tel.: 0131 448 3931

IV 68 NEWLINE

Balcony door with drop-down Gutman  
 aluminium threshold

Version:  
1

Date:  
15.05.14

Scale:  
1:1

Drawing:  
NN/13

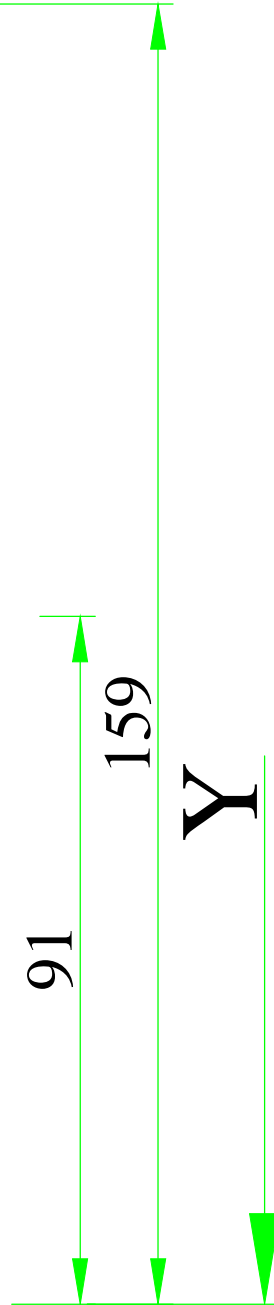
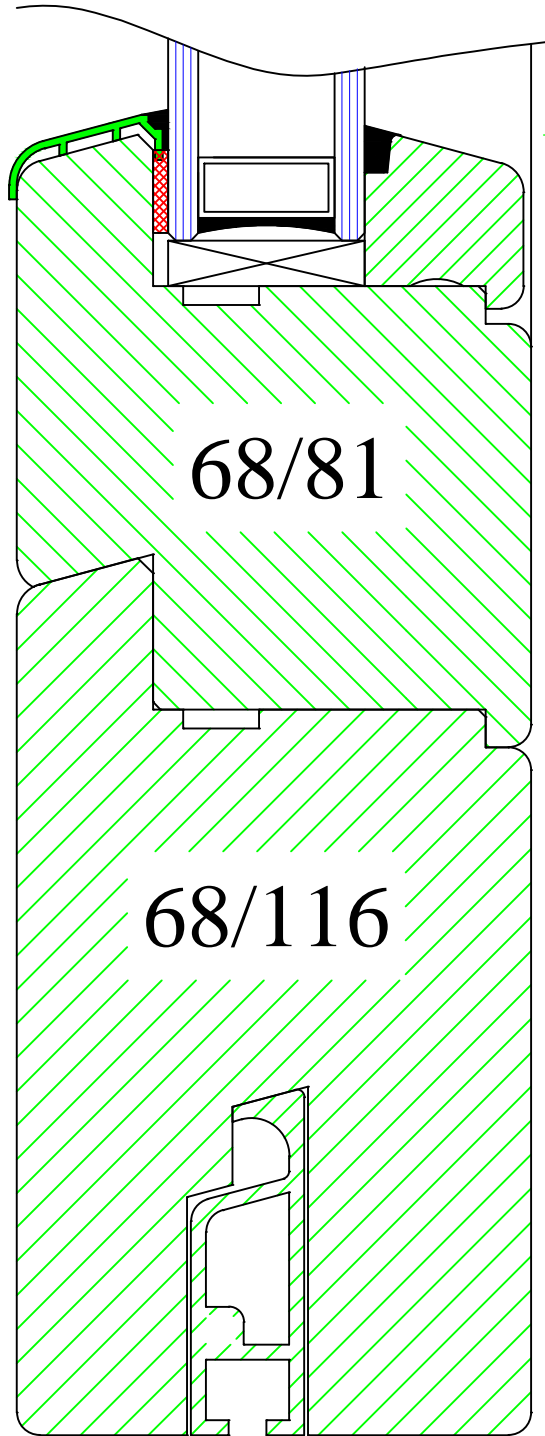
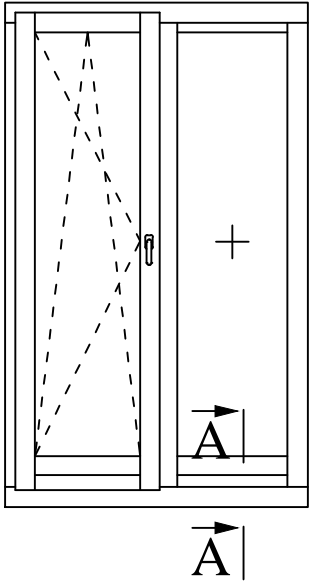



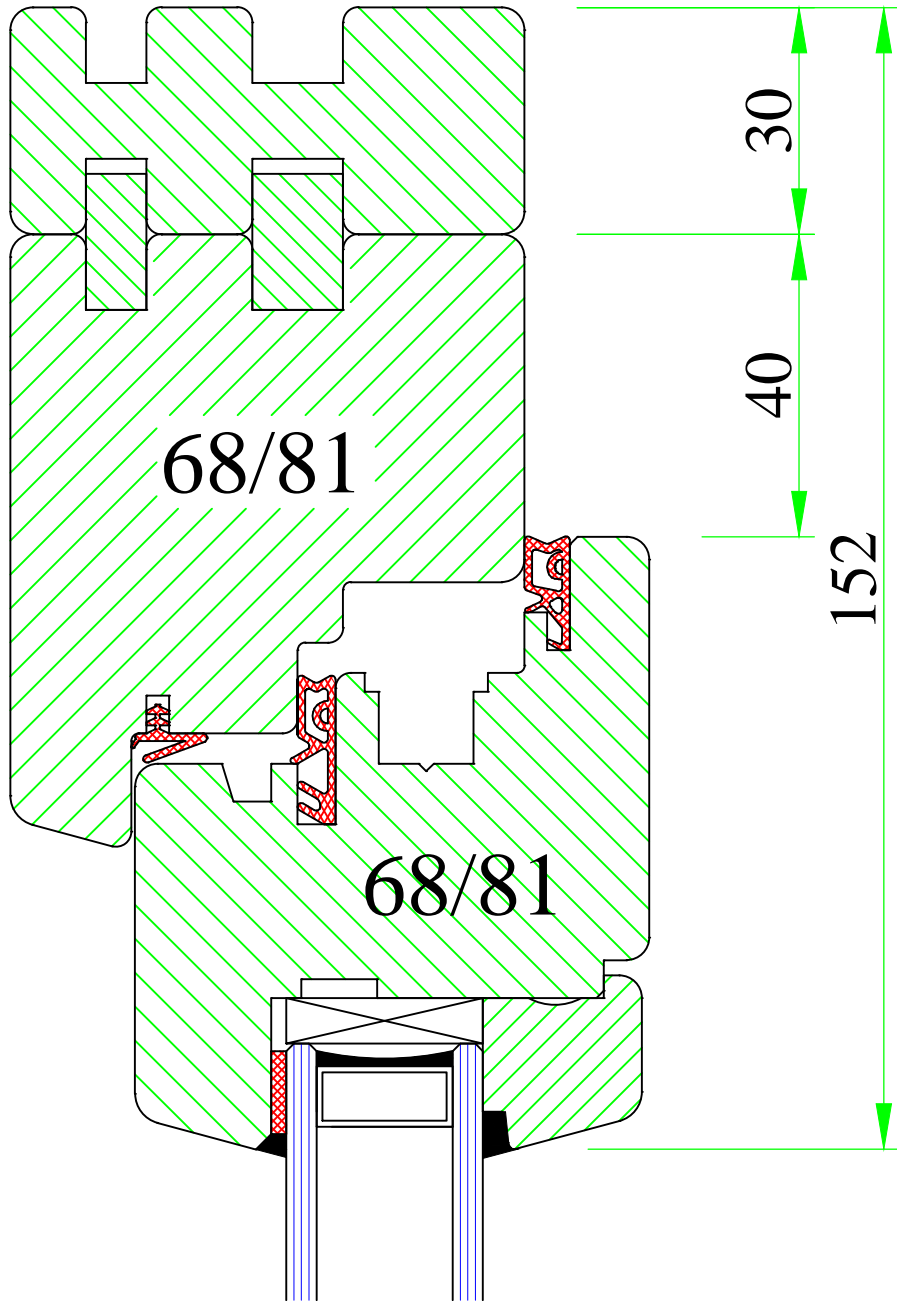
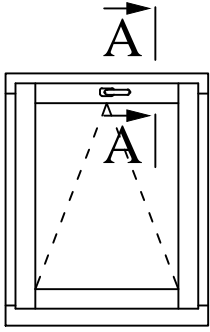

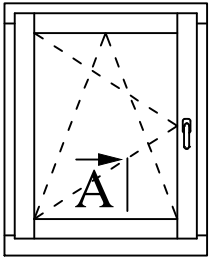

A

42

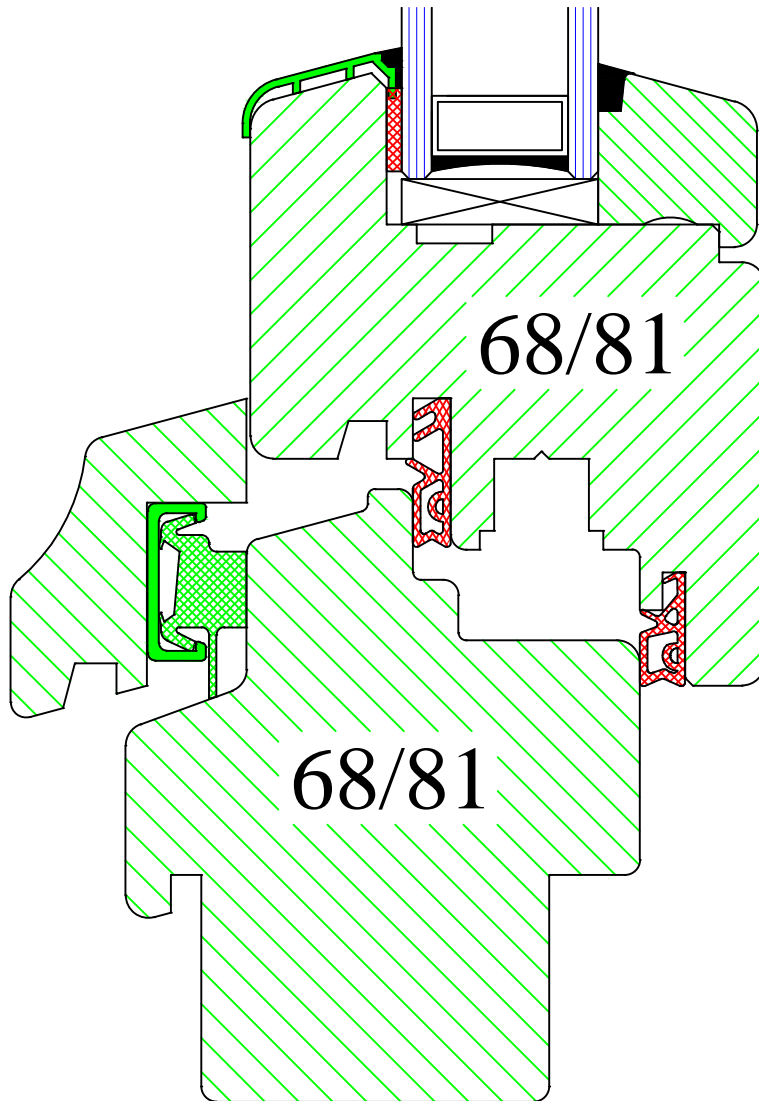

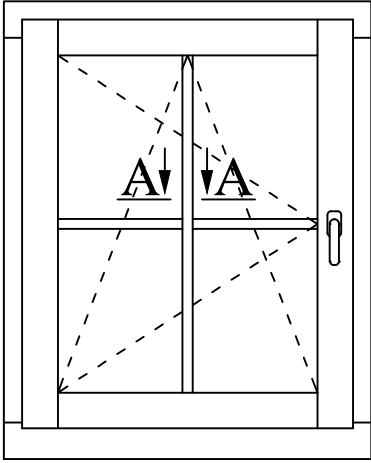

NN/16

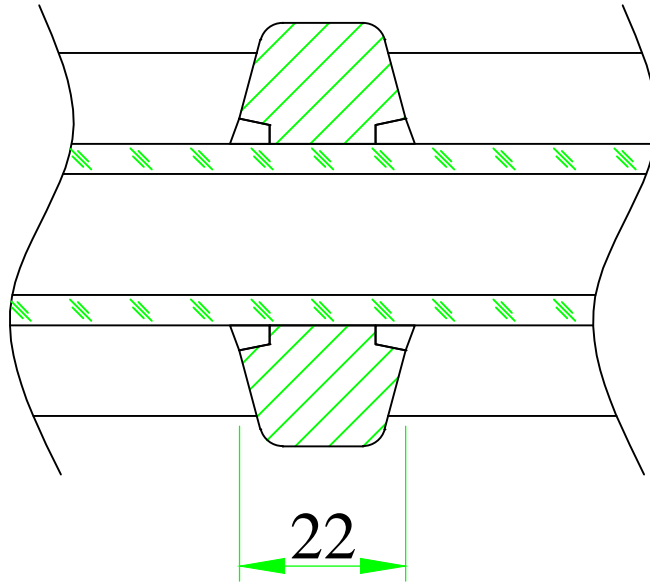

NN/16/1

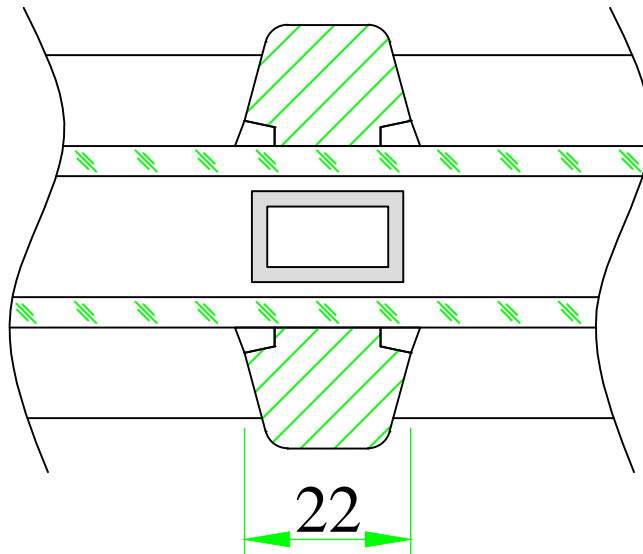

**UNI WINDOWS Ltd.**  
 Unit 6, Edgefield Industrial Est.  
 Loanhead, EH20 9TB  
 Tel.: 0131 448 3931

Georgian bar

IV 68 NEWLINE

Version:  
1

Scale:  
1:1

Date:  
15.05.14

Drawing:  
NN/16

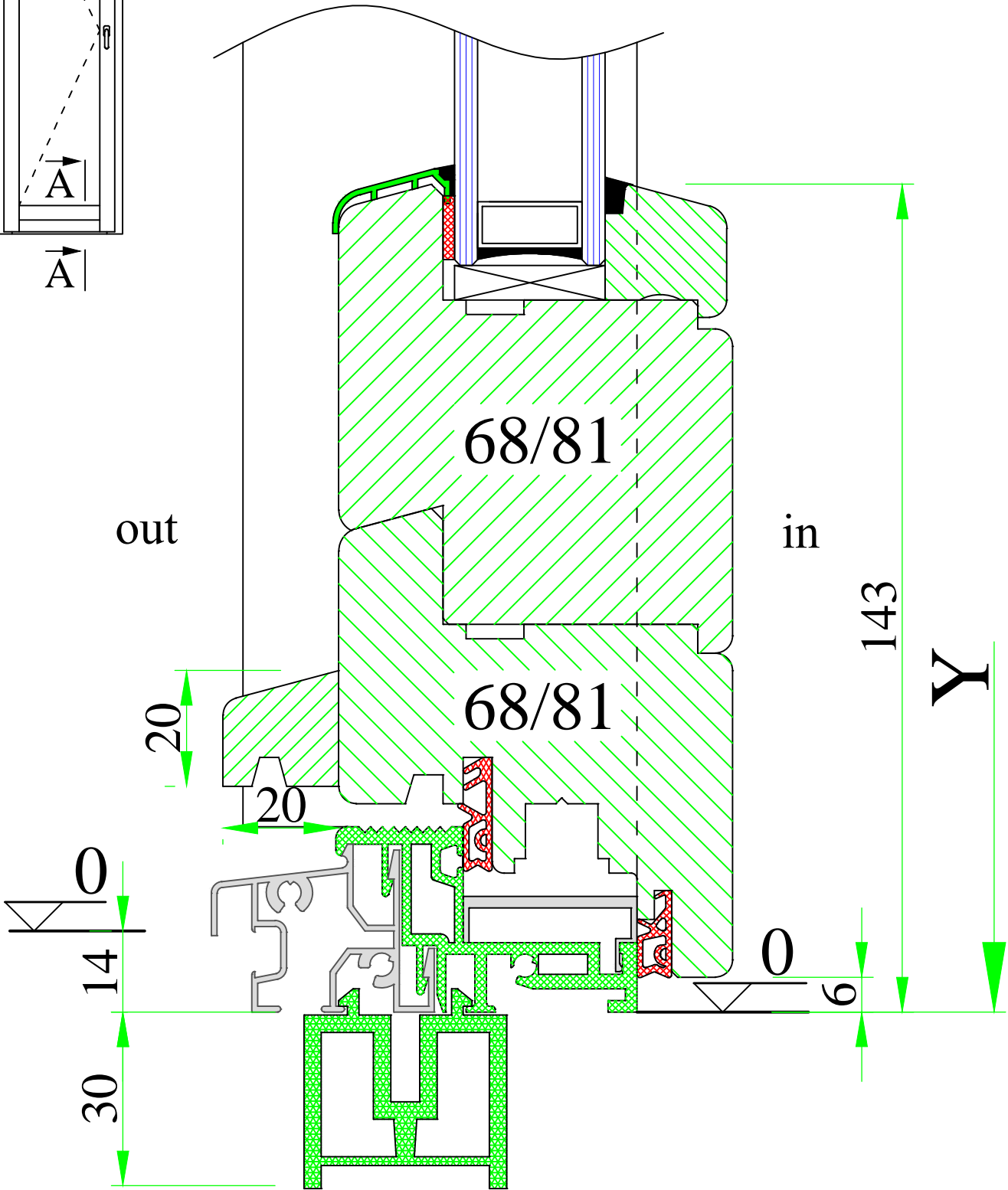
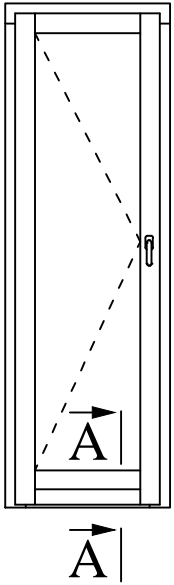

www.uniwin.co.uk



**UNI WINDOWS Ltd.**  
 Unit 6, Edgefield Industrial Est.  
 Loanhead, EH20 9TB  
 Tel.: 0131 448 3931

IV 68 NEWLINE  
 Balcony door with aluminium threshold  
 Wesser (new)

Version:  
 1  
 Date:  
 15.05.14

Scale:  
 1:1  
 Drawing:  
 NN/17

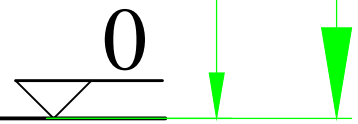
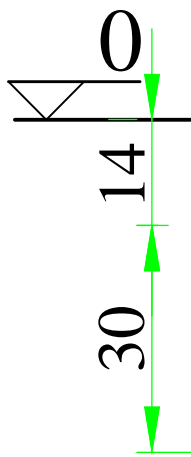
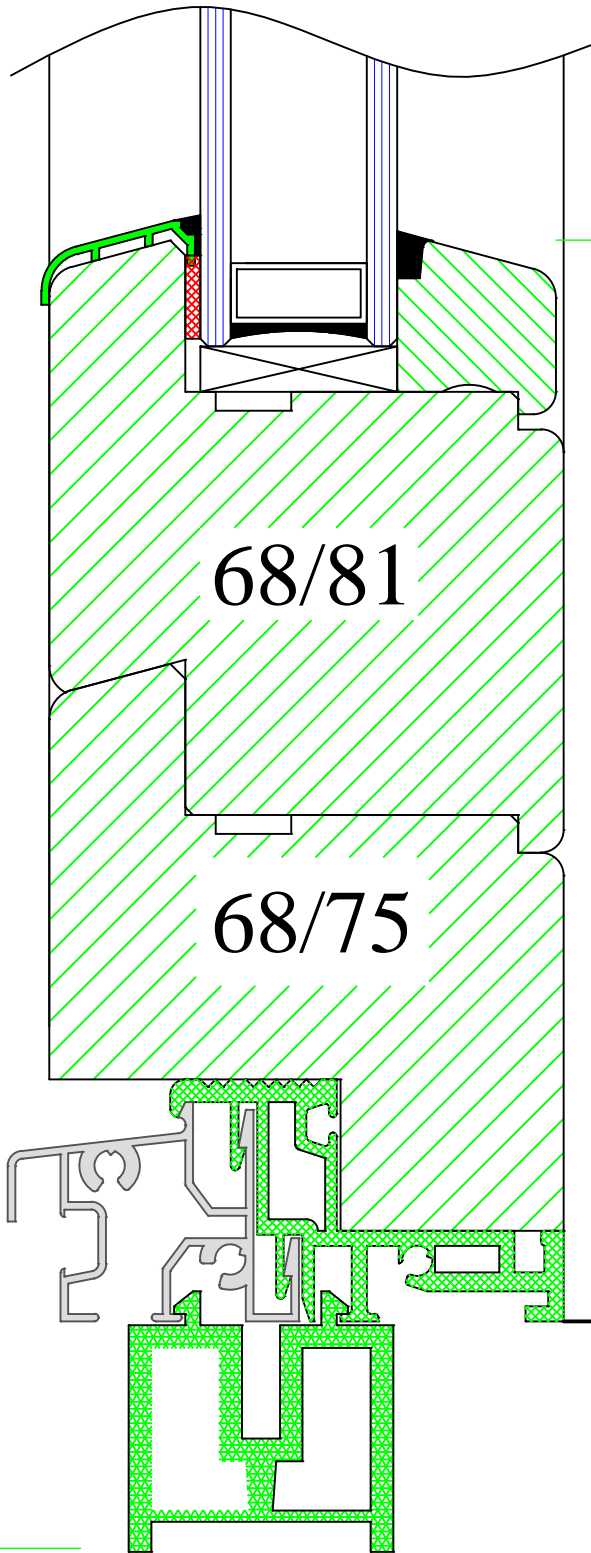
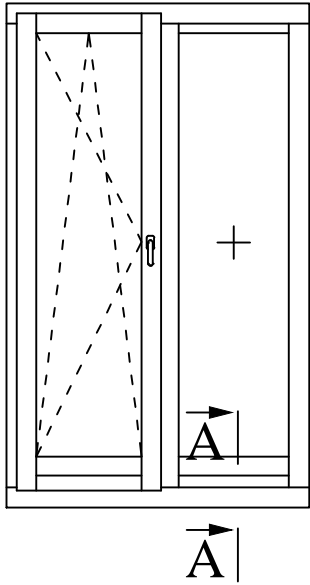

www.uniwin.co.uk



**UNI WINDOWS Ltd.**  
 Unit 6, Edgefield Industrial Est.  
 Loanhead, EH20 9TB  
 Tel.: 0131 448 3931

IV 68 NEWLINE

Frame extension for glass equalization with Wesser  
 aluminium threshold (new)

Version:  
1

Date:  
15.05.14

Scale:  
1:1

Drawing:  
NN/17-1

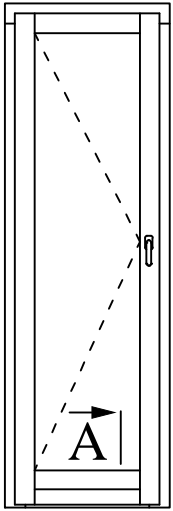

A

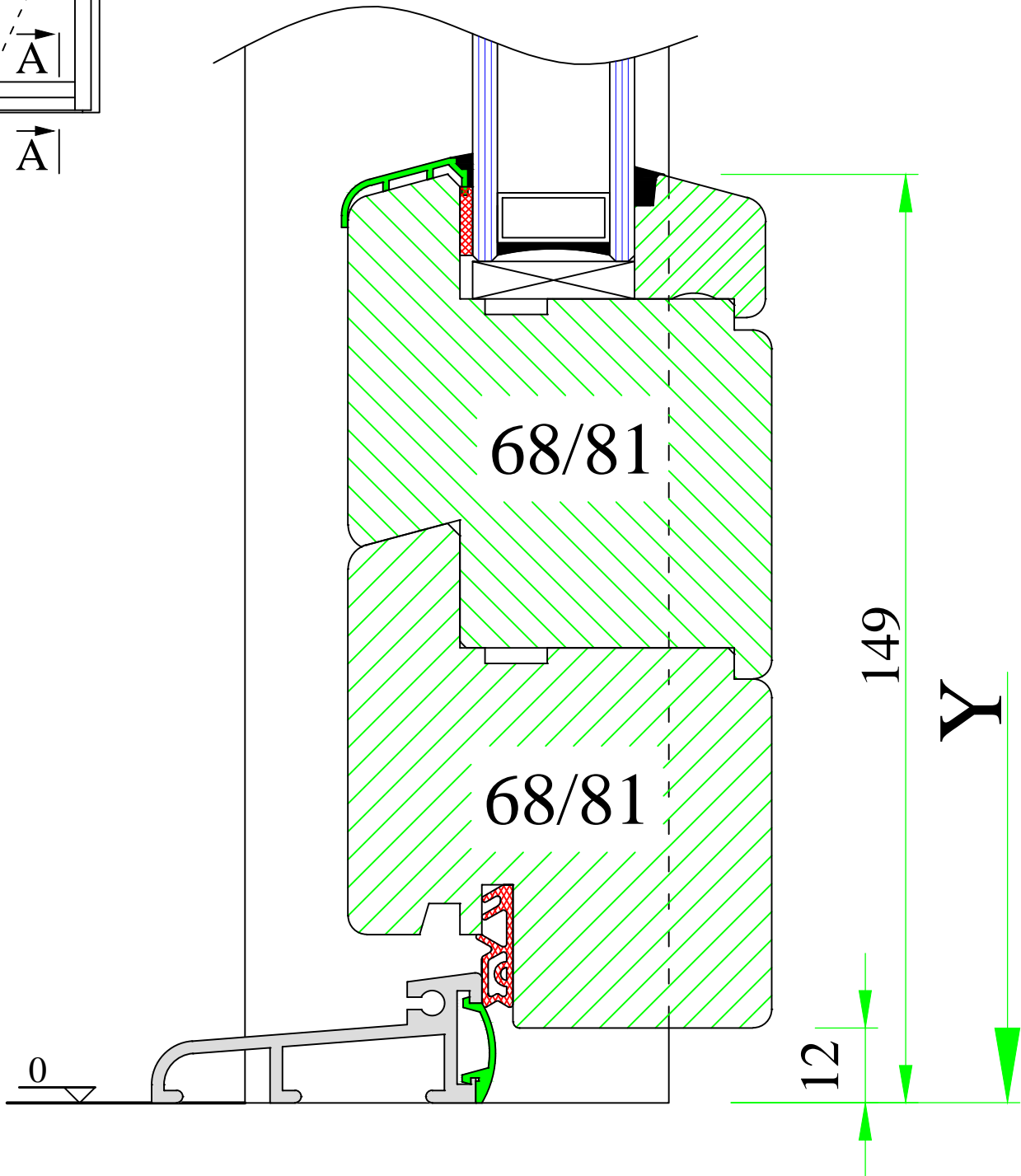

www.uniwin.co.uk



**UNI WINDOWS Ltd.**  
 Unit 6, Edgefield Industrial Est.  
 Loanhead, EH20 9TB  
 Tel.: 0131 448 3931

IV 68 NEWLINE

Balcony door with flat threshold Wesser (old)

Version:  
1

Scale:  
1:1

Date:  
15.05.14

Drawing:  
NN/18

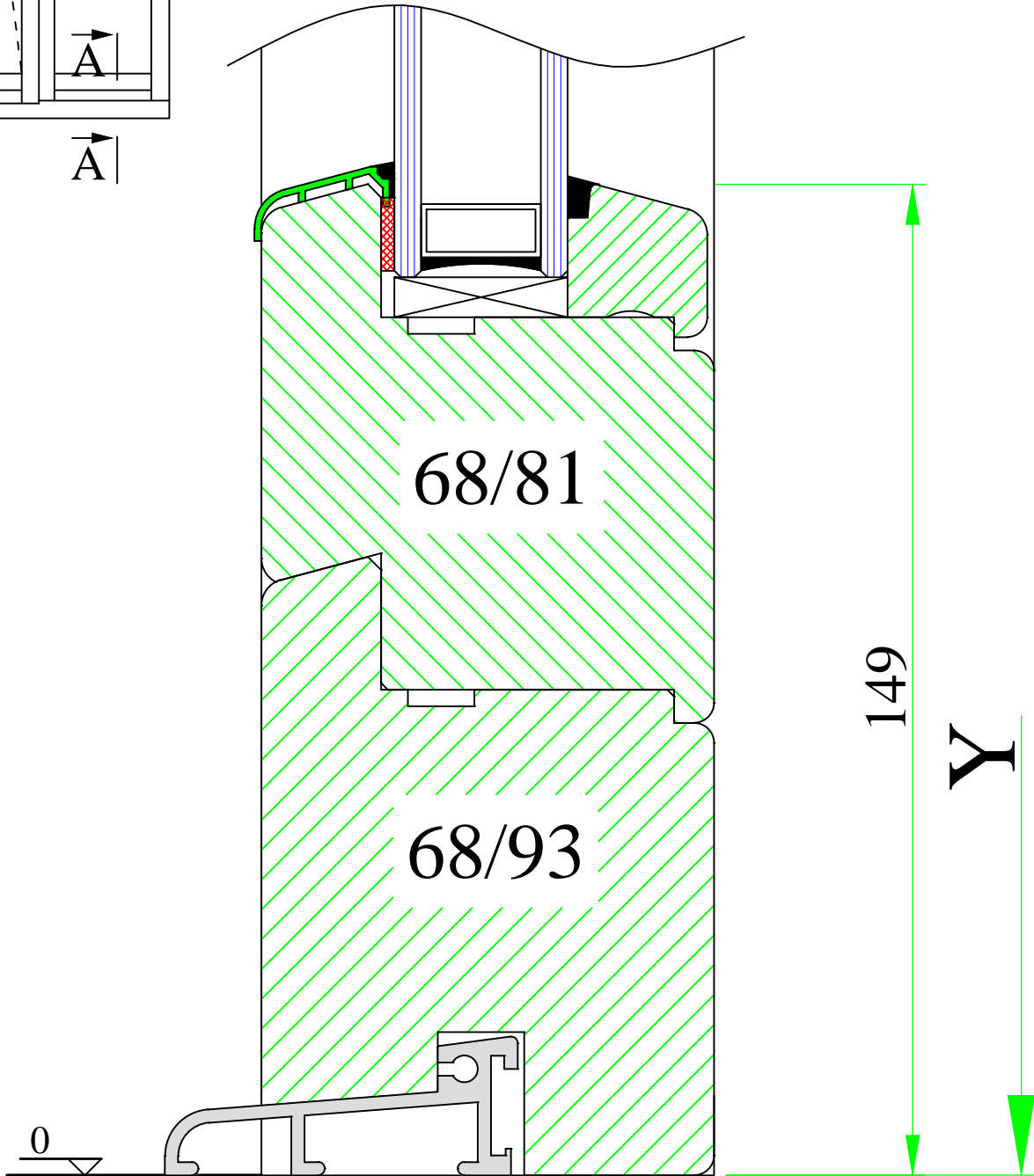
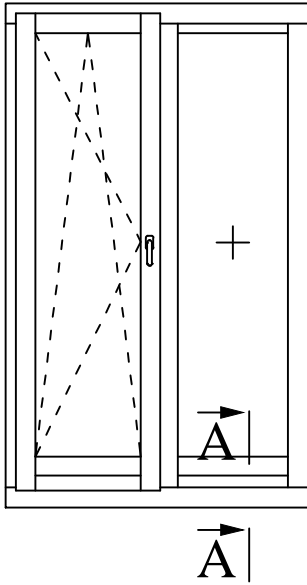

www.uniwin.co.uk



**UNI WINDOWS Ltd.**  
 Unit 6, Edgefield Industrial Est.  
 Loanhead, EH20 9TB  
 Tel.: 0131 448 3931

IV 68 NEWLINE

Frame extension for glass equalization with  
 Wesser flat threshold (old)

Version:  
 1

Scale:  
 1:1

Date:  
 15.05.14

Drawing:  
 NN/18-1

NN/19

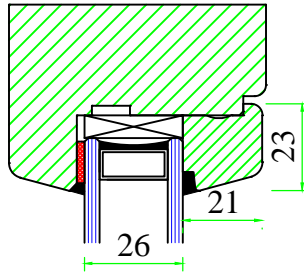

NN/19/1

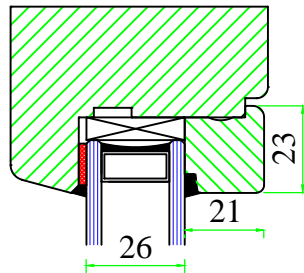

NN/19/2

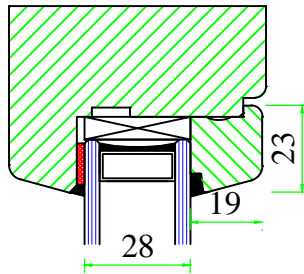

NN/19/3

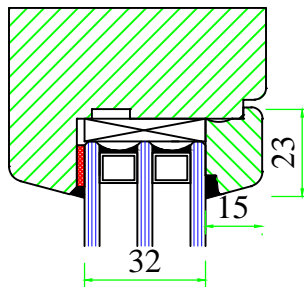



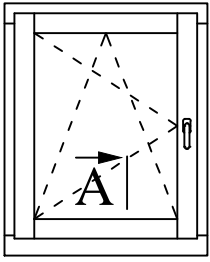

A

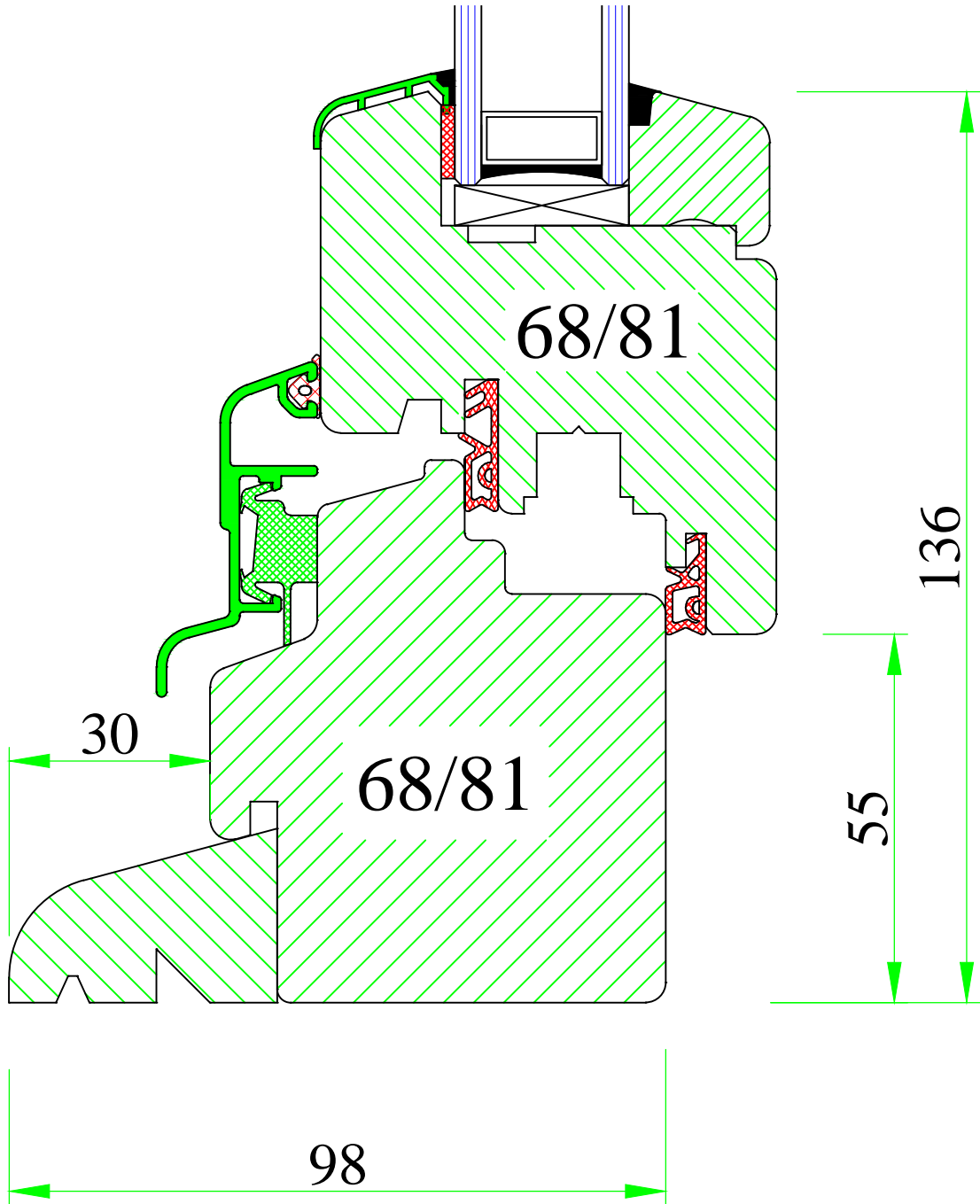

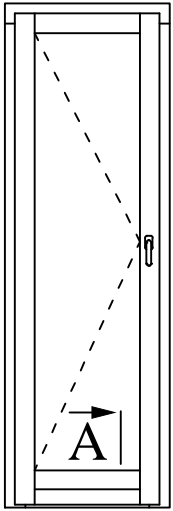

A

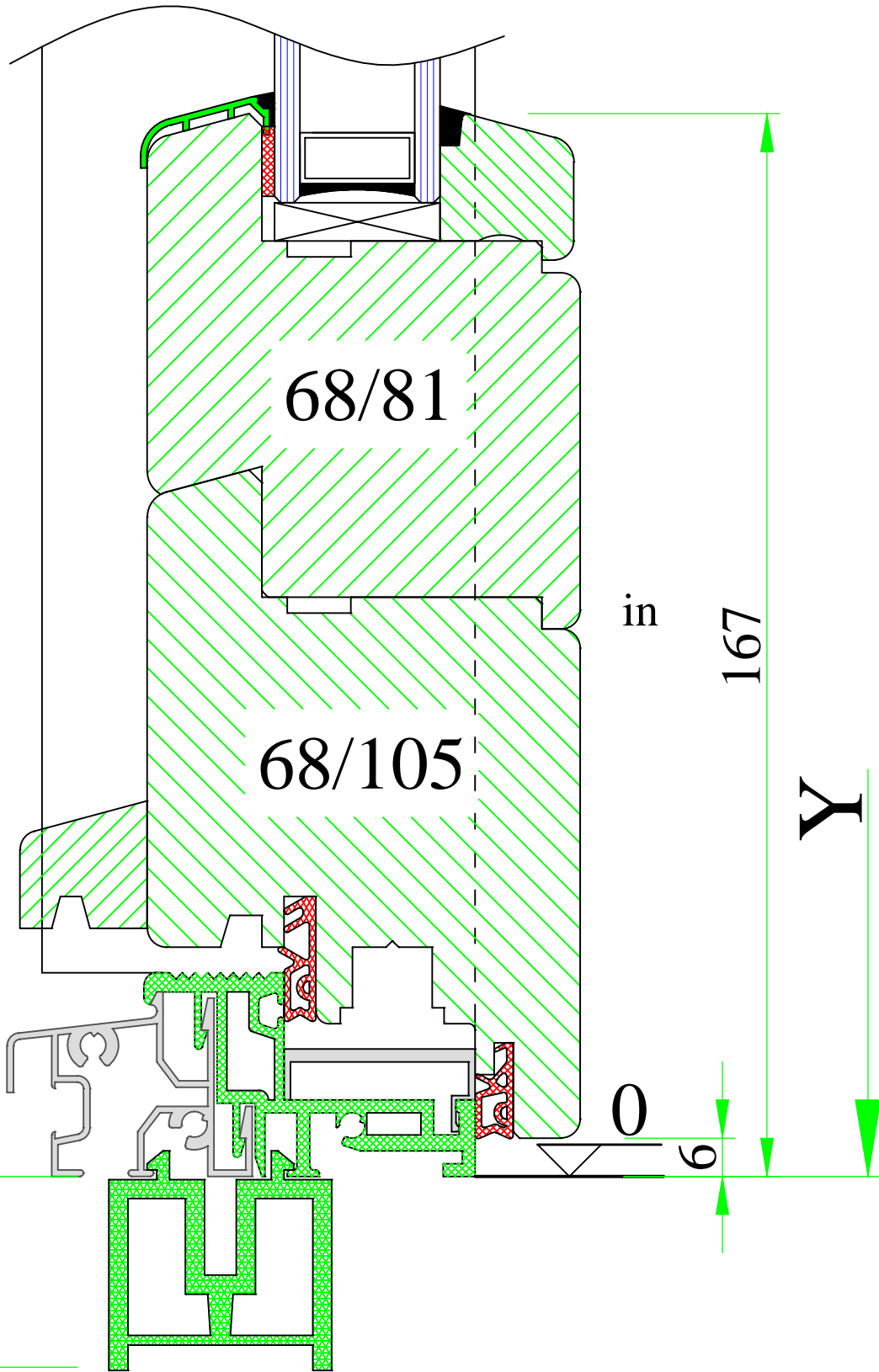

out

in

68/81

68/105

167

Y

0

14

30

0

6



**UNI WINDOWS Ltd.**  
 Unit 6, Edgefield Industrial Est.  
 Loanhead, EH20 9TB  
 Tel.: 0131 448 3931

IV 68 NEWLINE  
 Balcony door with Wesser aluminium  
 treshold (new)

Version:  
 1  
 Date:  
 15.05.14

Scale:  
 1:1  
 Drawing:  
 NN/21

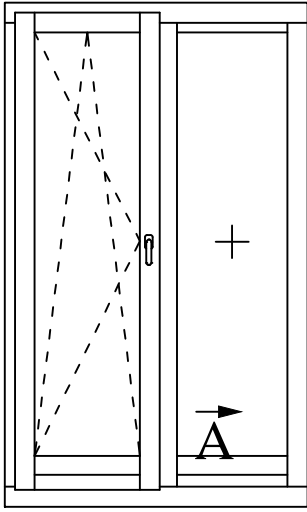

A

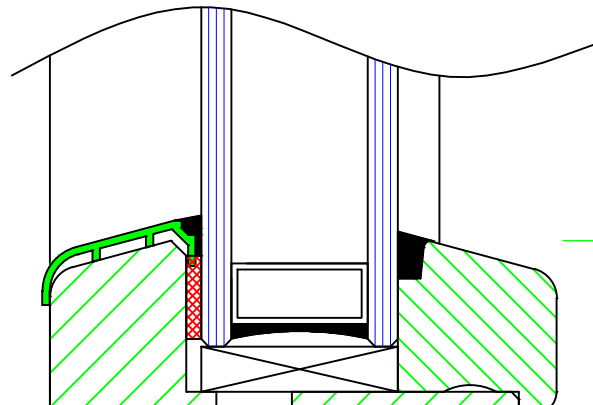

68/81

out

in

167

68/99

Y

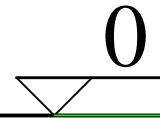
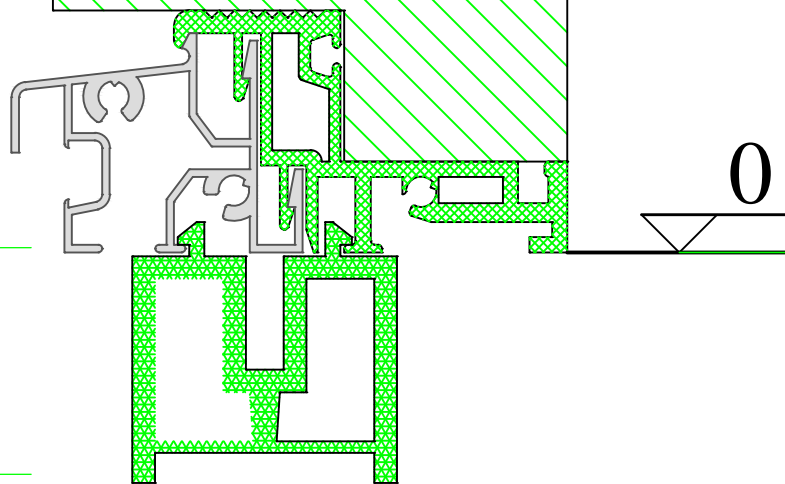
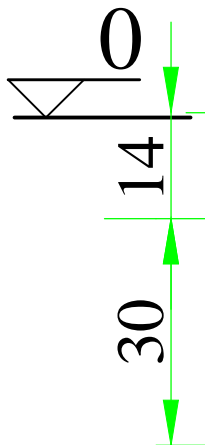

**UNI WINDOWS Ltd.**  
 Unit 6, Edgefield Industrial Est.  
 Loanhead, EH20 9TB  
 Tel.: 0131 448 3931

IV 68 NEWLINE

Frame extension for glass equalization with  
 Wesser aluminium threshold (new)

Version:  
1

Scale:  
1:1

Date:  
15.05.14

Drawing:  
NN/21-1

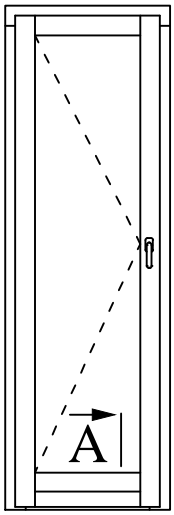

A

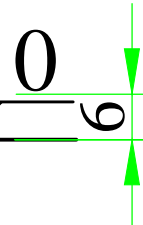
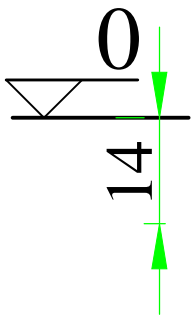
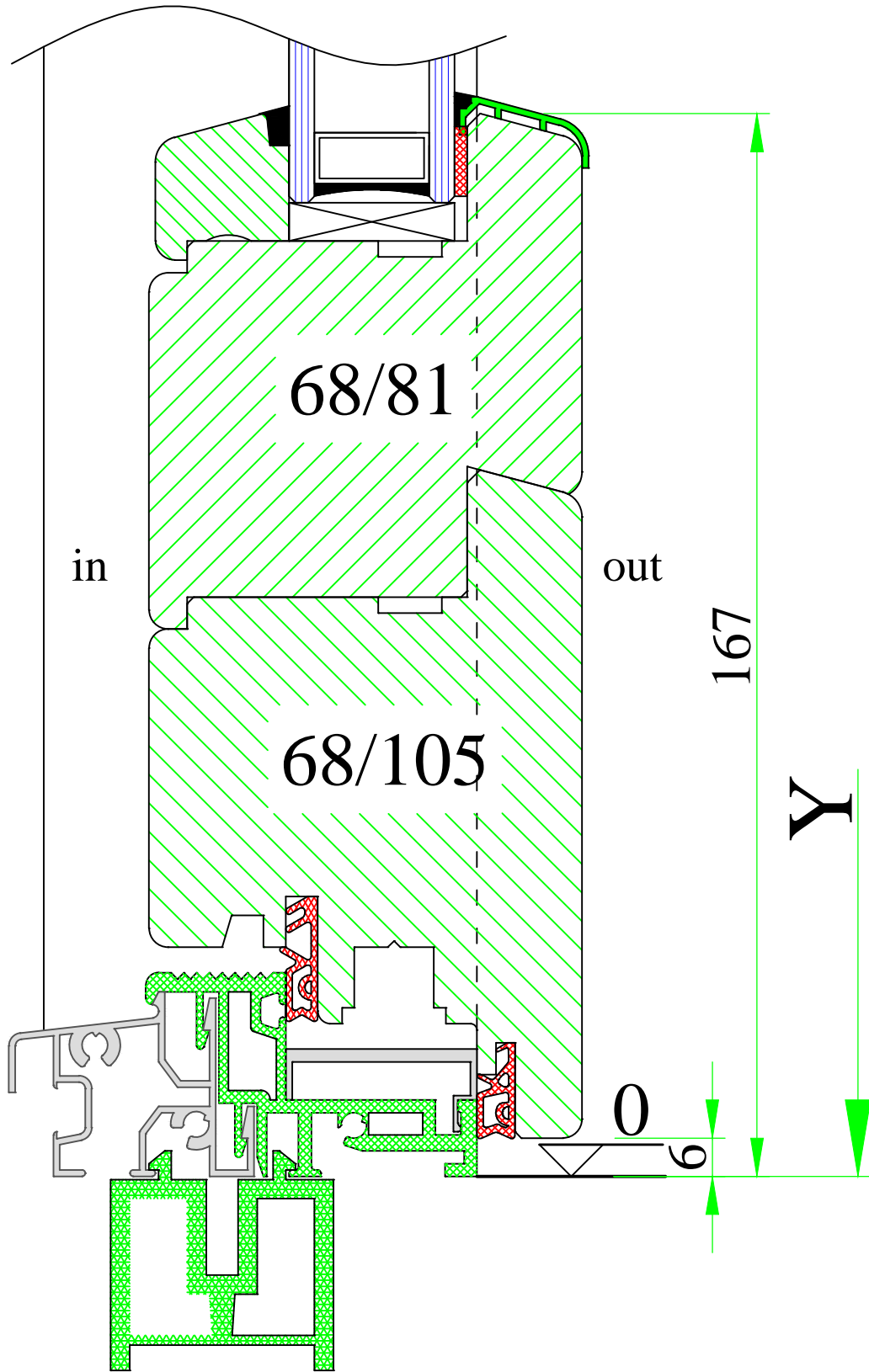

www.uniwin.co.uk



**UNI WINDOWS Ltd.**  
 Unit 6, Edgefield Industrial Est.  
 Loanhead, EH20 9TB  
 Tel.: 0131 448 3931

IV 68 NEWLINE  
 Balcony door with Wesser new threshold –  
 inward opening

Version: 1	Scale: 1:1
Date: 15.05.14	Drawing: NN/22

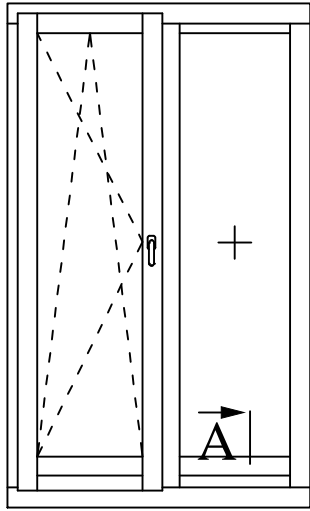

A

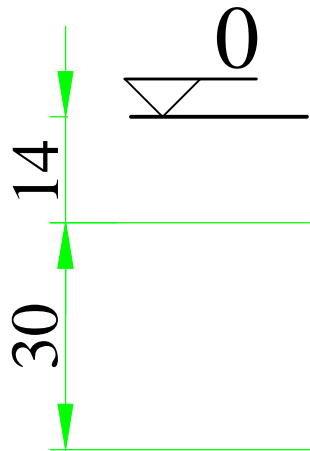
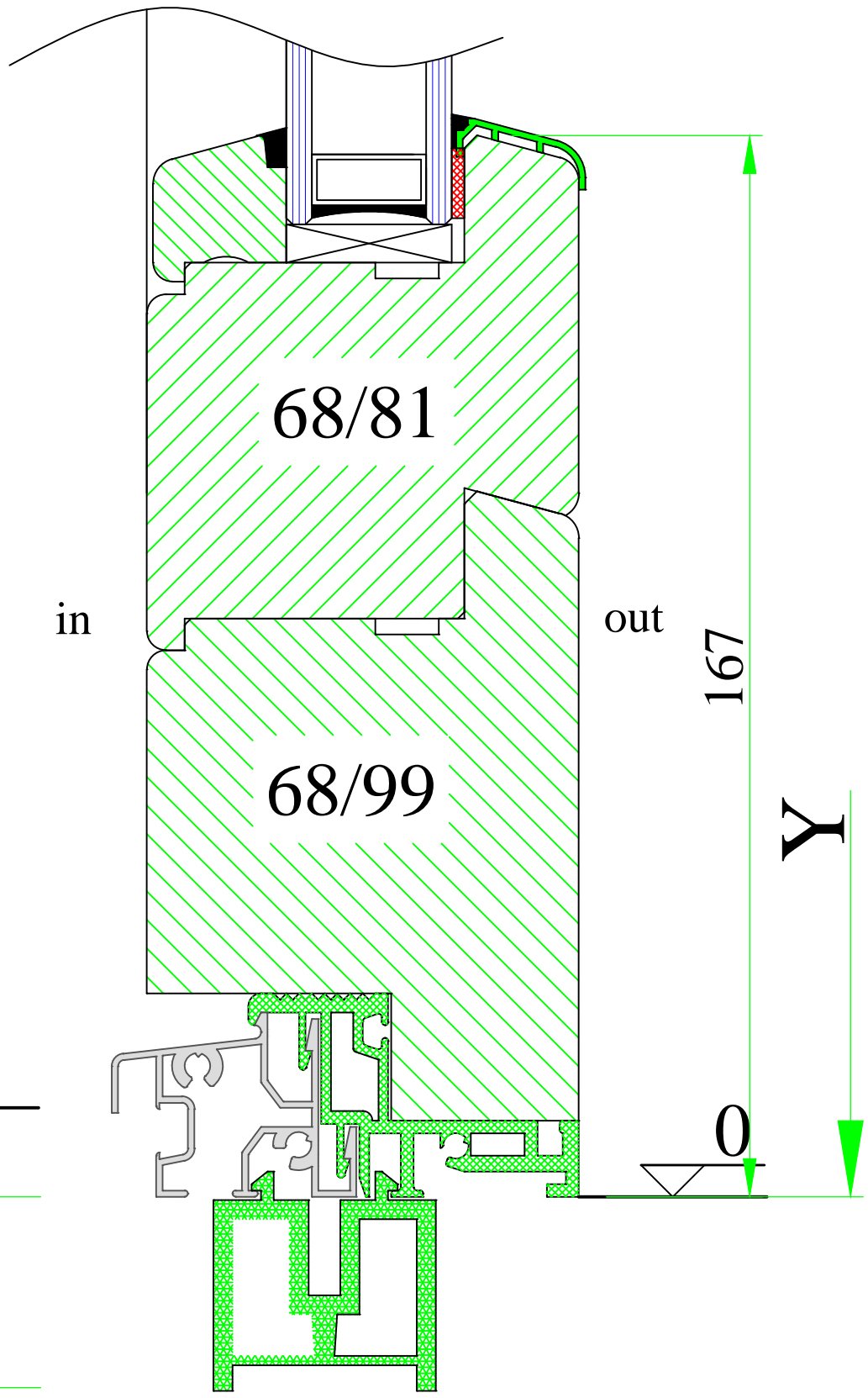

www.uniwin.co.uk



**UNI WINDOWS Ltd.**  
 Unit 6, Edgefield Industrial Est.  
 Loanhead, EH20 9TB  
 Tel.: 0131 448 3931

IV 68 NEWLINE  
 Frame extension for glass equalization  
 with Wesser aluminium threshold (new)

Version: 1	Scale: 1:1
Date: 15.05.14	Drawing: NN/22-1

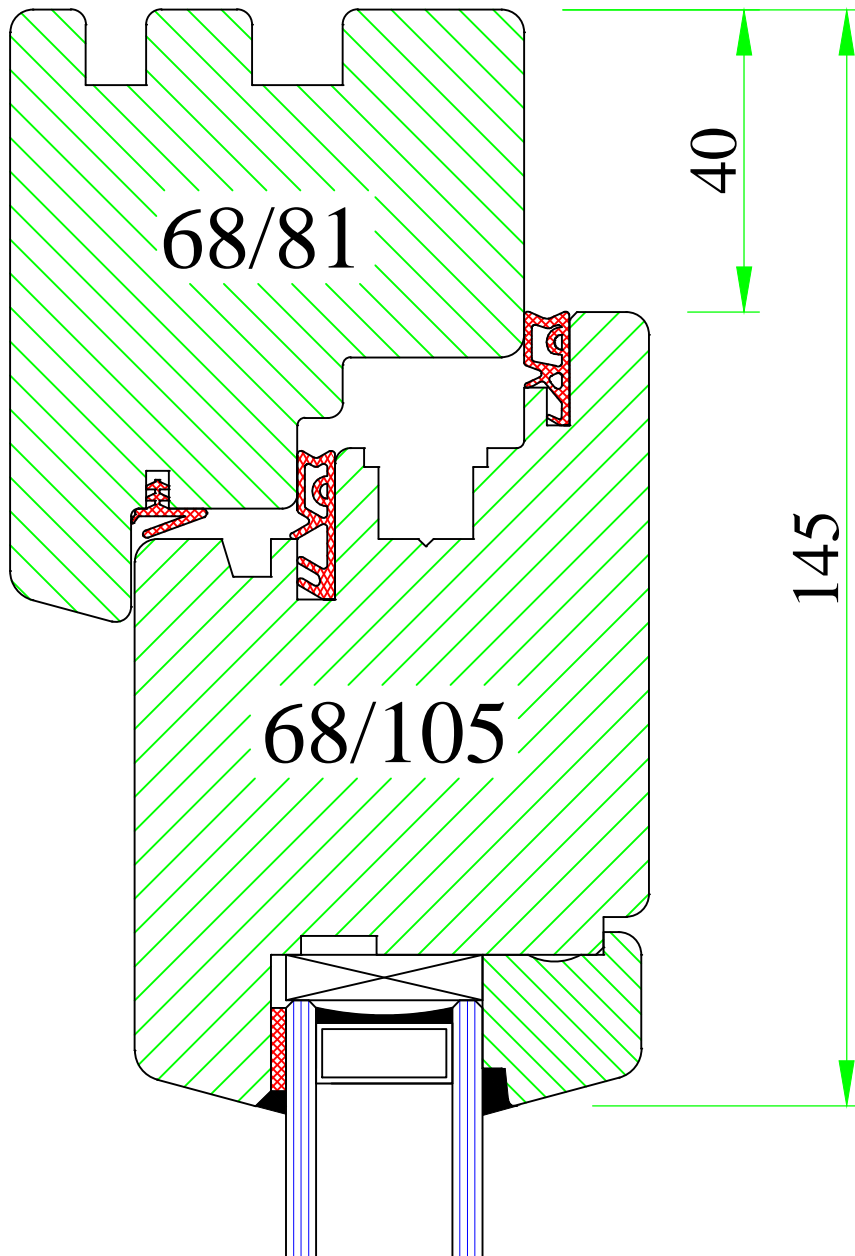
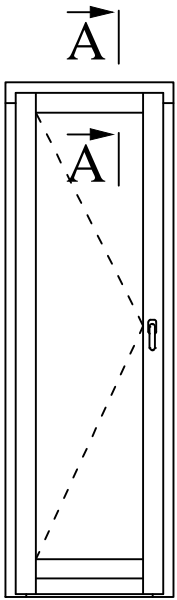

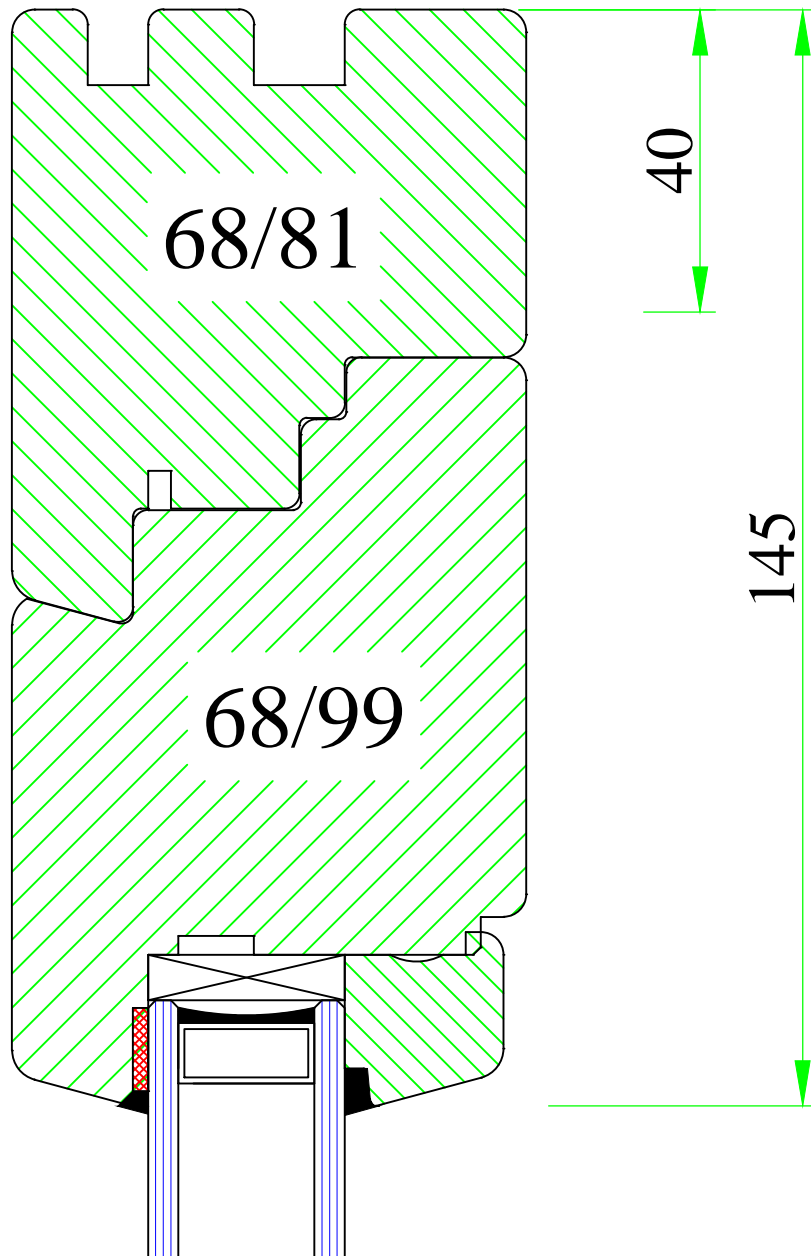
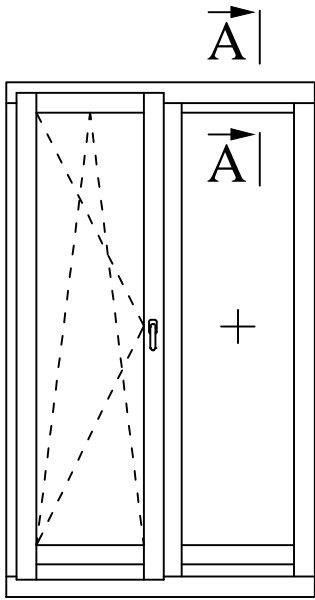

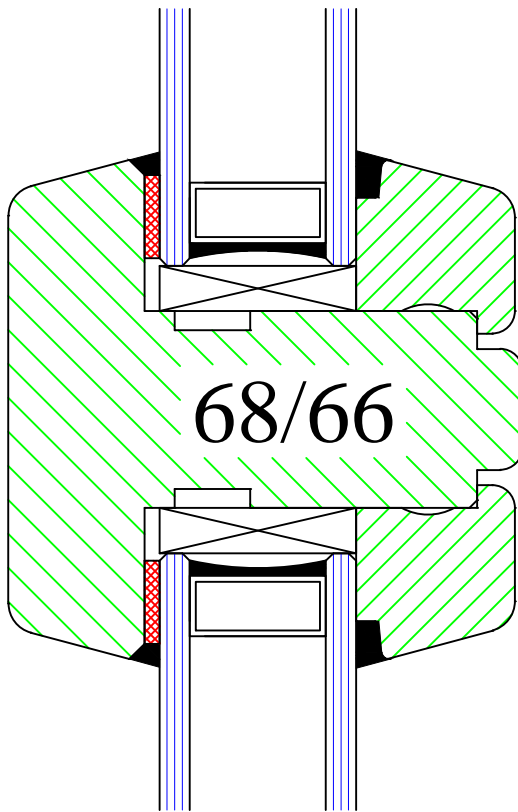
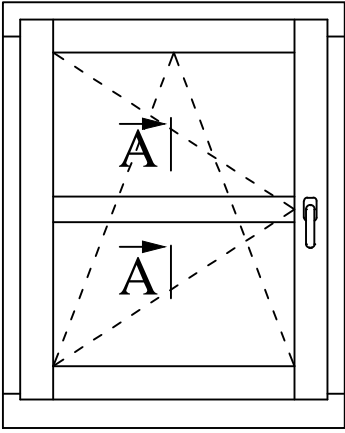

66/81/105/110/120/136



**UNI WINDOWS Ltd.**  
 Unit 6, Edgefield Industrial Est.  
 Loanhead, EH20 9TB  
 Tel.: 0131 448 3931

Astragal construction

IV 68 NEWLINE

Version:  
1

Scale:  
1:1

Date:  
15.05.14

Drawing:  
NN/24



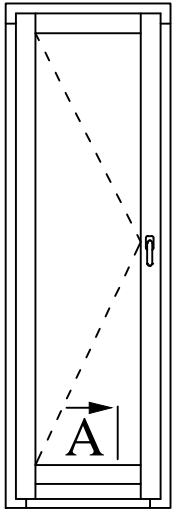

A

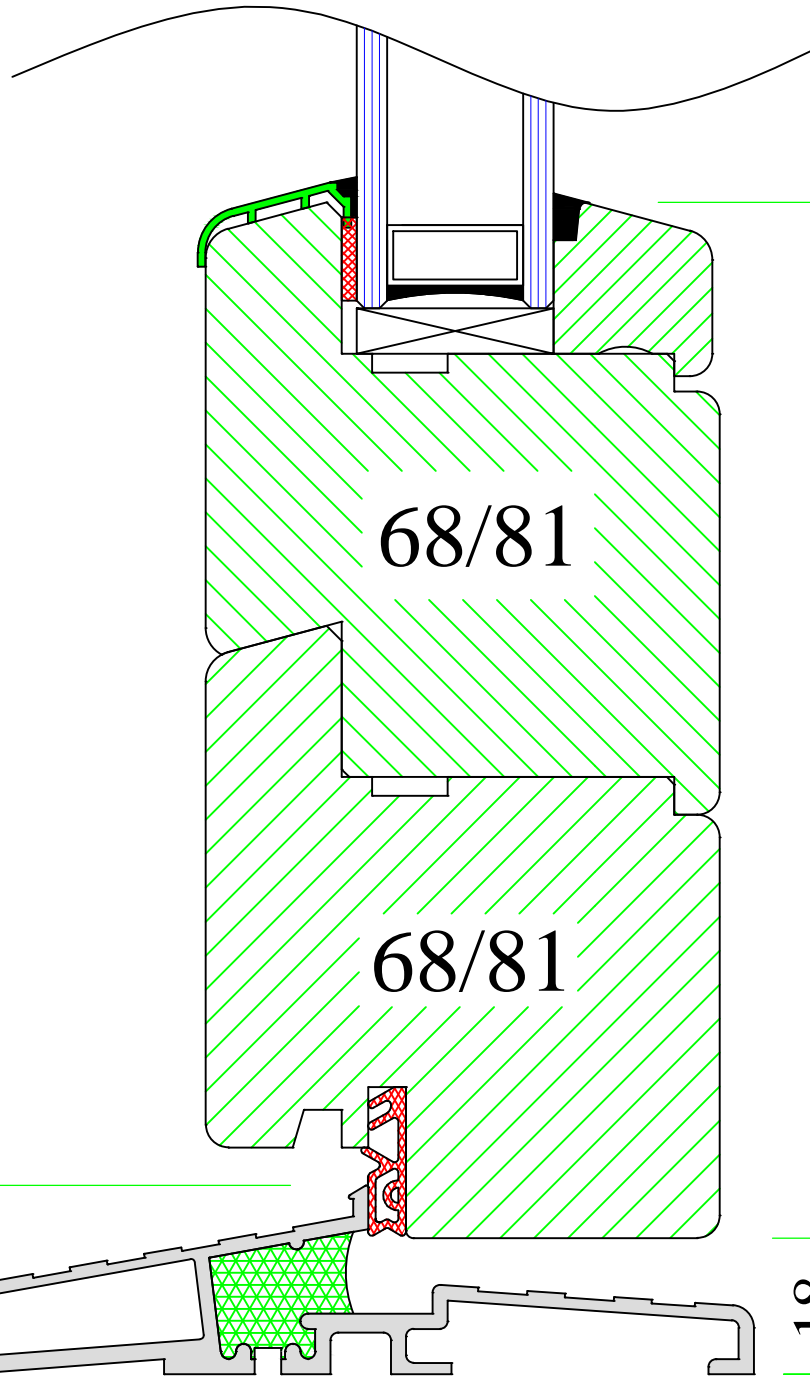

25

0

155

Y

18

www.uniwin.co.uk



**UNI WINDOWS Ltd.**  
 Unit 6, Edgefield Industrial Est.  
 Loanhead, EH20 9TB  
 Tel.: 0131 448 3931

IV 68 NEWLINE

Balcony door with aluminium threshold Dafa

Version:  
1

Scale:  
1:1

Date:  
15.05.14

Drawing:  
NN/25

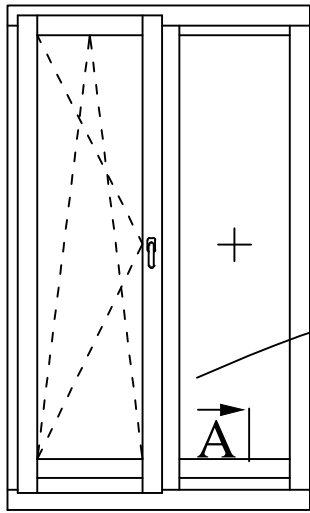

A

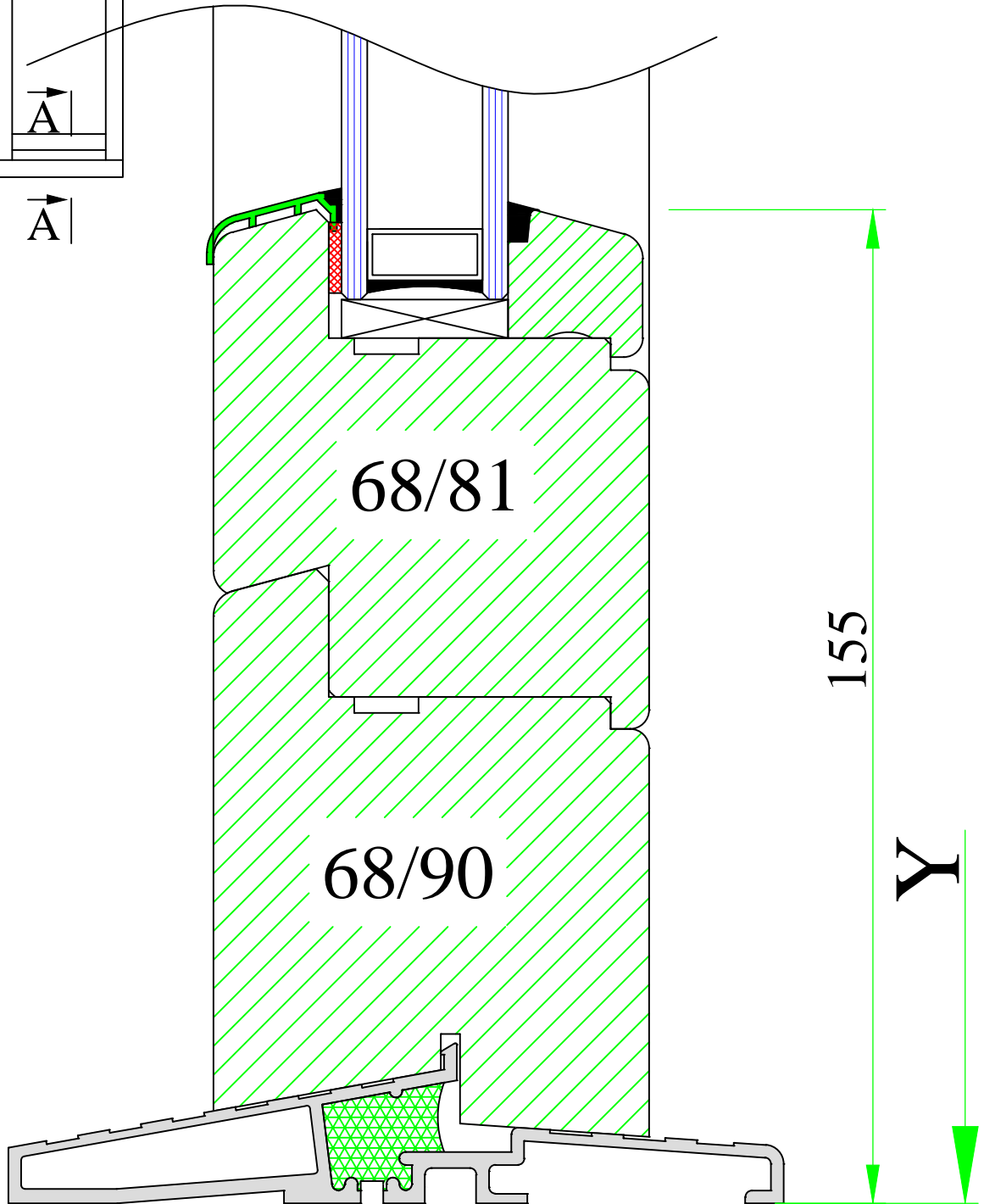

www.uniwin.co.uk



**UNI WINDOWS Ltd.**  
 Unit 6, Edgefield Industrial Est.  
 Loanhead, EH20 9TB  
 Tel.: 0131 448 3931

IV 68 NEWLINE

Balcony door with aluminium threshold Dafa

Version:  
1

Scale:  
1:1

Date:  
15.05.14

Drawing:  
NN/25-1

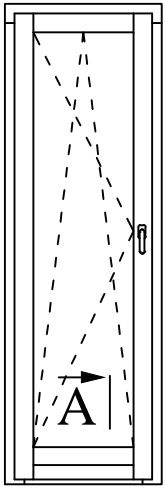

A

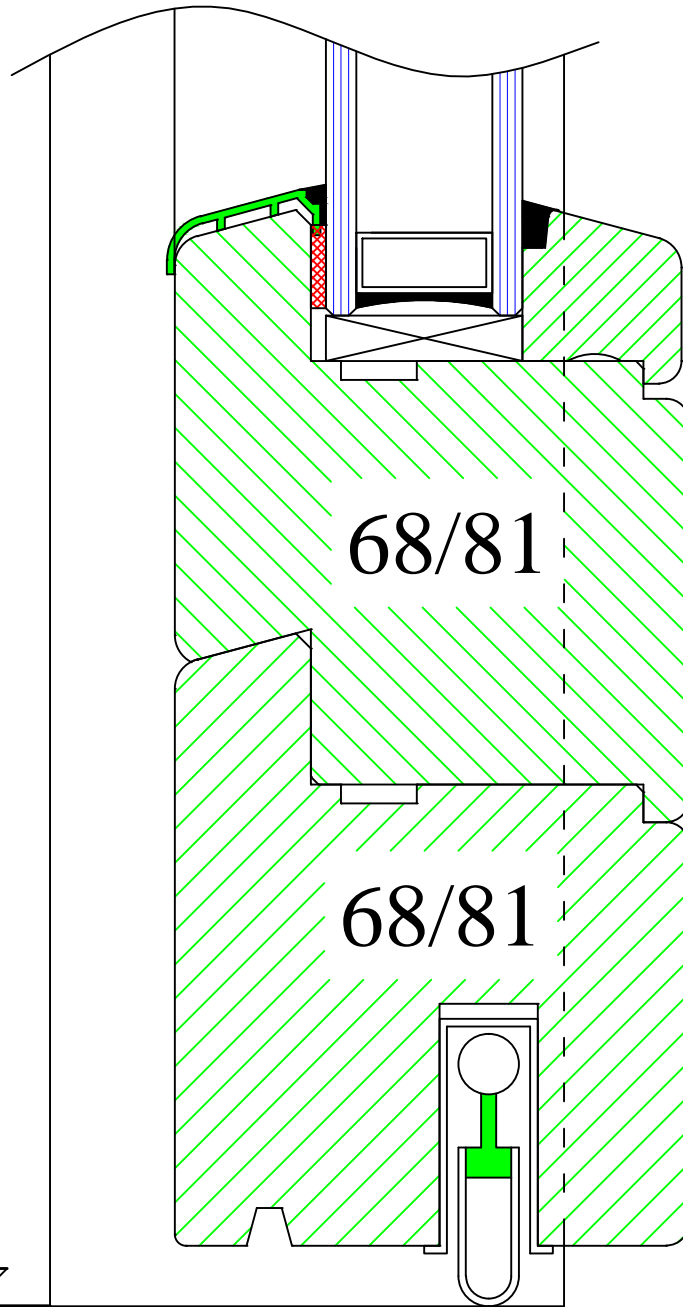

145

Y

8

0

www.uniwin.co.uk



**UNI WINDOWS Ltd.**  
 Unit 6, Edgefield Industrial Est.  
 Loanhead, EH20 9TB  
 Tel.: 0131 448 3931

IV 68 NEWLINE

Balcony door without threshold, movable gasket

Version:  
1

Scale:  
1:1

Date:  
15.05.14

Drawing:  
NN/26

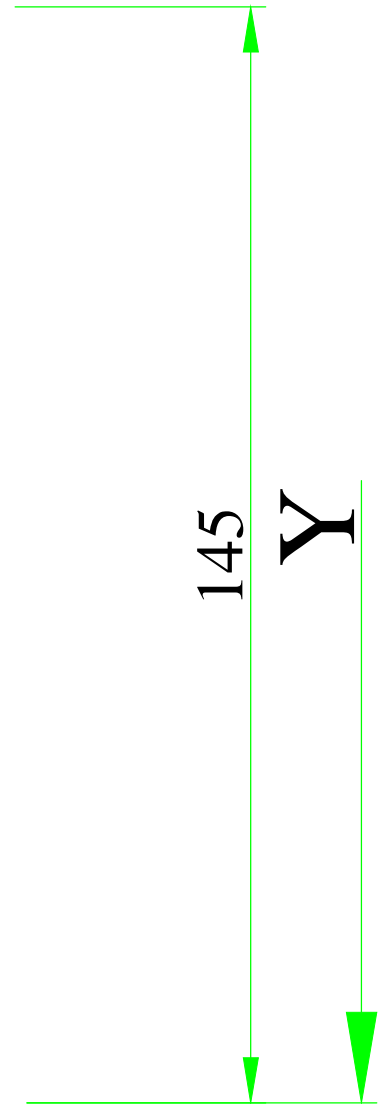
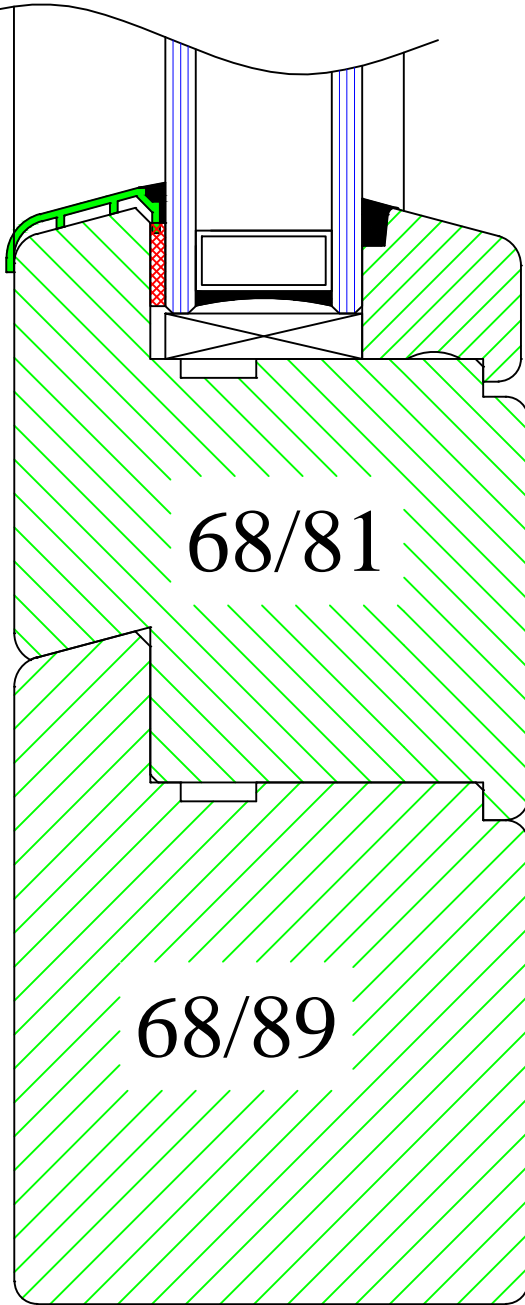
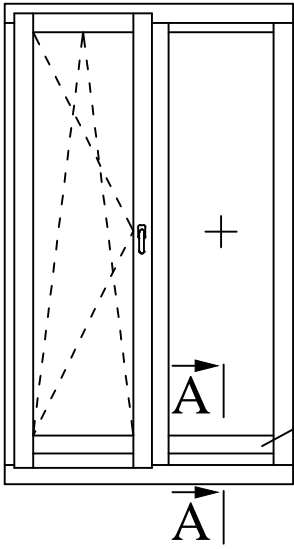

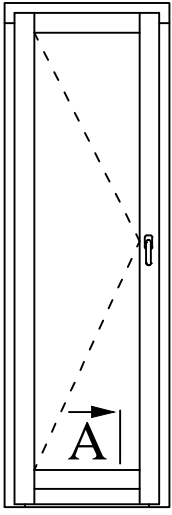

A

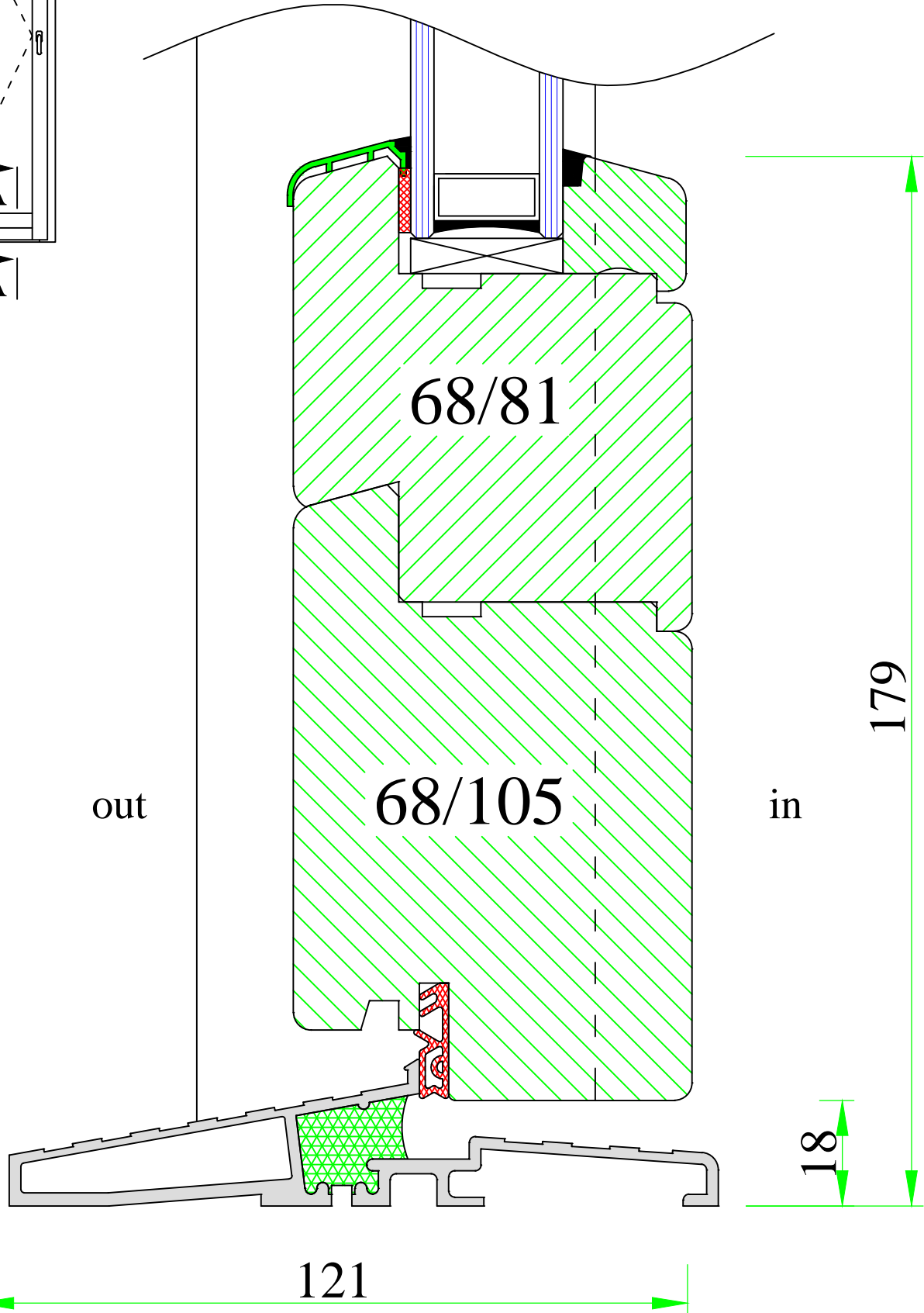

121

179  
18

out

in

68/81

68/105



**UNI WINDOWS Ltd.**  
 Unit 6, Edgefield Industrial Est.  
 Loanhead, EH20 9TB  
 Tel.: 0131 448 3931

IV 68 NEWLINE

French door with Dafa threshold

Version:  
1

Scale:  
1:1

Date:  
15.05.14

Drawing:  
NN/27

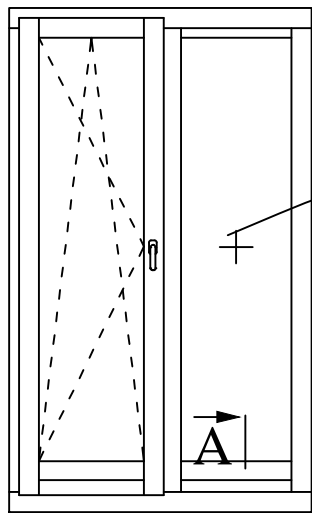

A

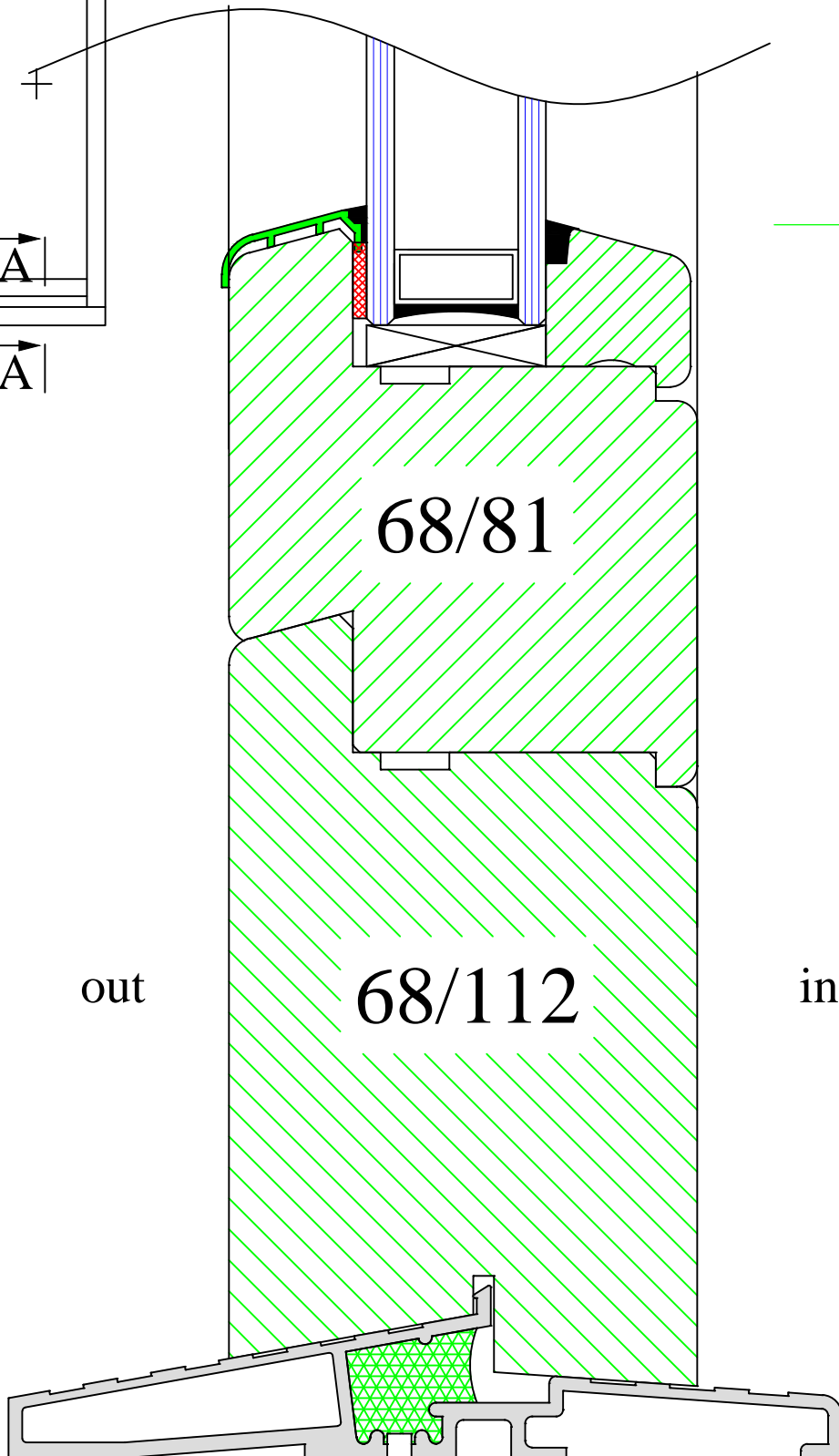

179

Y

out

68/112

in

www.uniwin.co.uk



**UNI WINDOWS Ltd.**  
 Unit 6, Edgefield Industrial Est.  
 Loanhead, EH20 9TB  
 Tel.: 0131 448 3931

IV 68 NEWLINE

French door with Dafa threshold

Version:  
1

Scale:  
1:1

Date:  
15.05.14

Drawing:  
NN/27-1

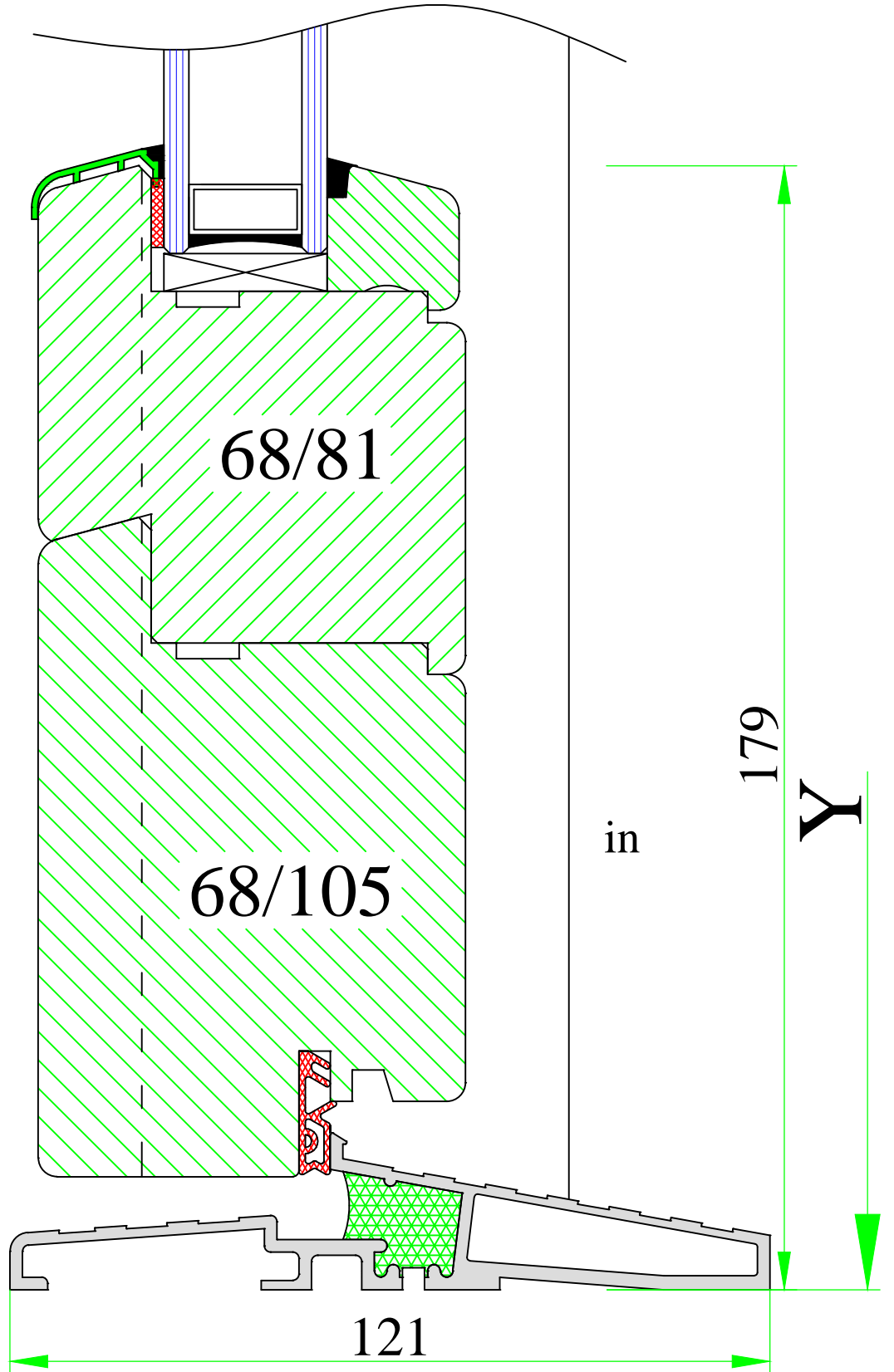
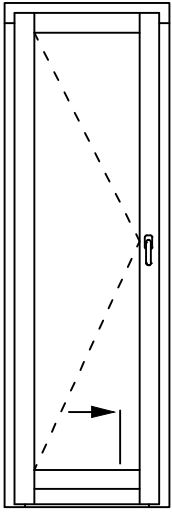

www.uniwin.co.uk



**UNI WINDOWS Ltd.**  
 Unit 6, Edgefield Industrial Est.  
 Loanhead, EH20 9TB  
 Tel.: 0131 448 3931

IV 68 NEWLINE

French door with Dafa threshold

Version:  
1

Scale:  
1:1

Date:  
15.05.14

Drawing:  
NN/28

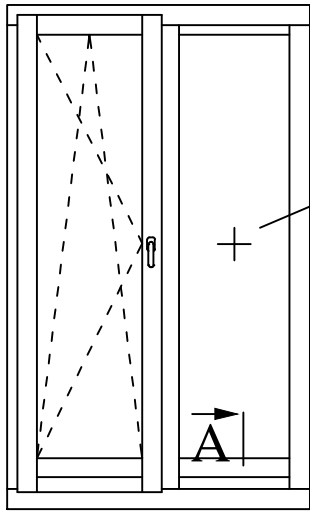

A

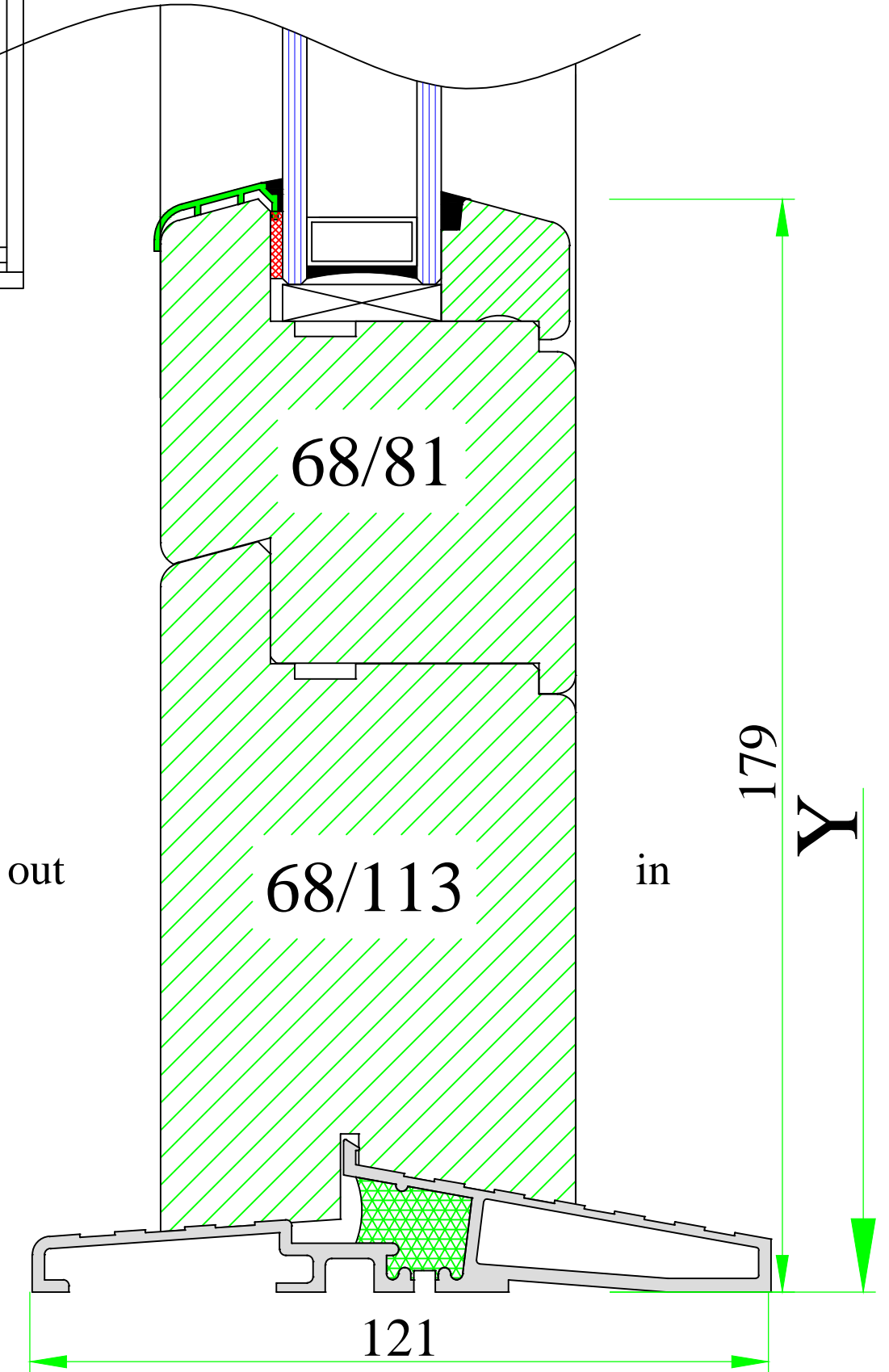

www.uniwin.co.uk



**UNI WINDOWS Ltd.**  
 Unit 6, Edgefield Industrial Est.  
 Loanhead, EH20 9TB  
 Tel.: 0131 448 3931

IV 68 NEWLINE  
 French door with Dafa threshold

Version: 1	Scale: 1:1
Date: 15.05.14	Drawing: NN/28-1



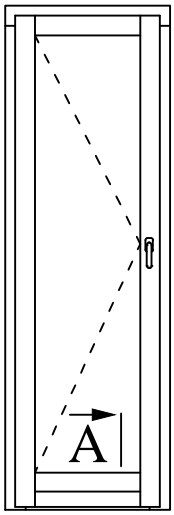

A

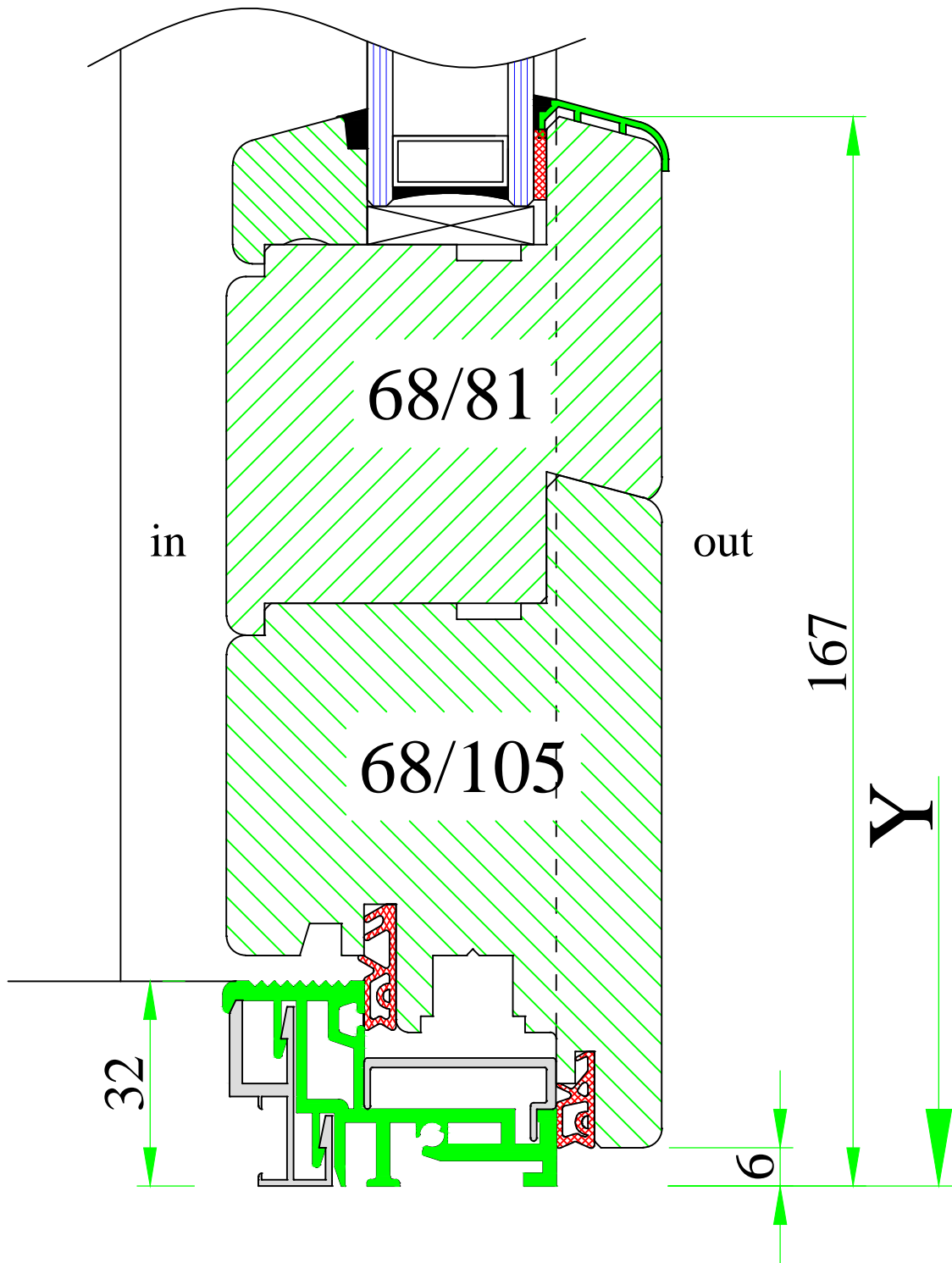

www.uniwin.co.uk



**UNI WINDOWS Ltd.**  
 Unit 6, Edgefield Industrial Est.  
 Loanhead, EH20 9TB  
 Tel.: 0131 448 3931

IV 68 NEWLINE

French door with WesserA aluminium  
 threshold – inward opening

Version:  
 1

Date:  
 15.05.14

Scale:  
 1:1

Drawing:  
 NN/29

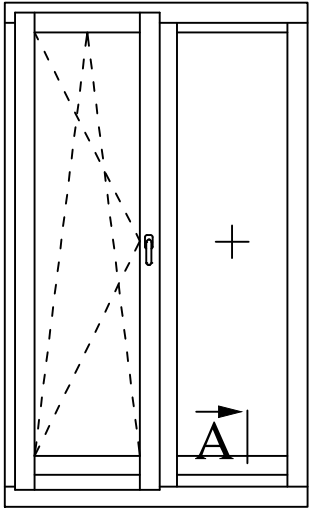

A

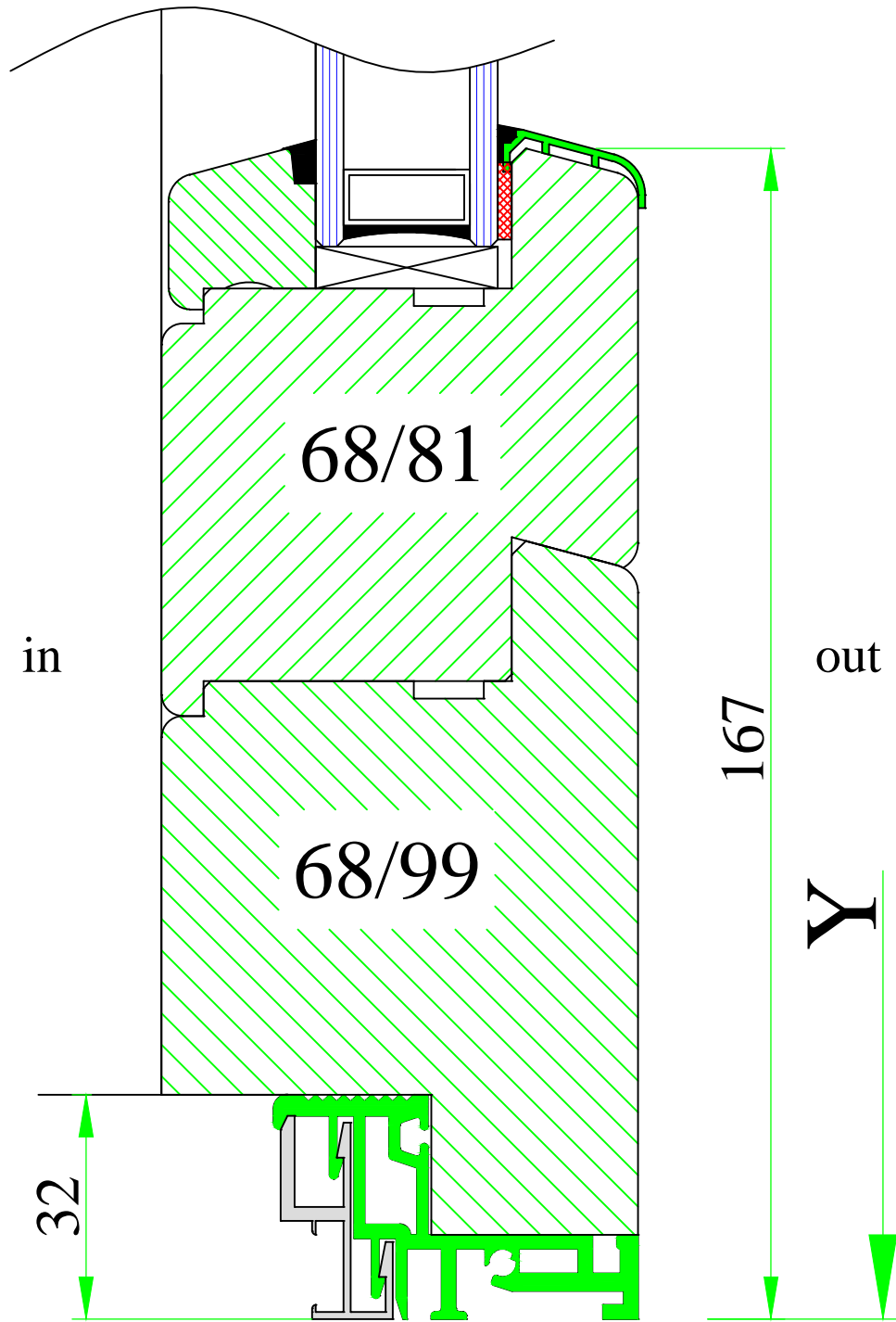

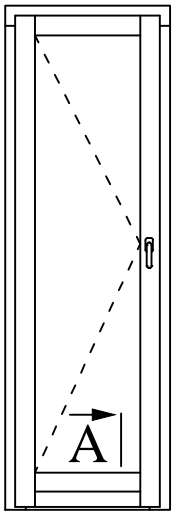

A

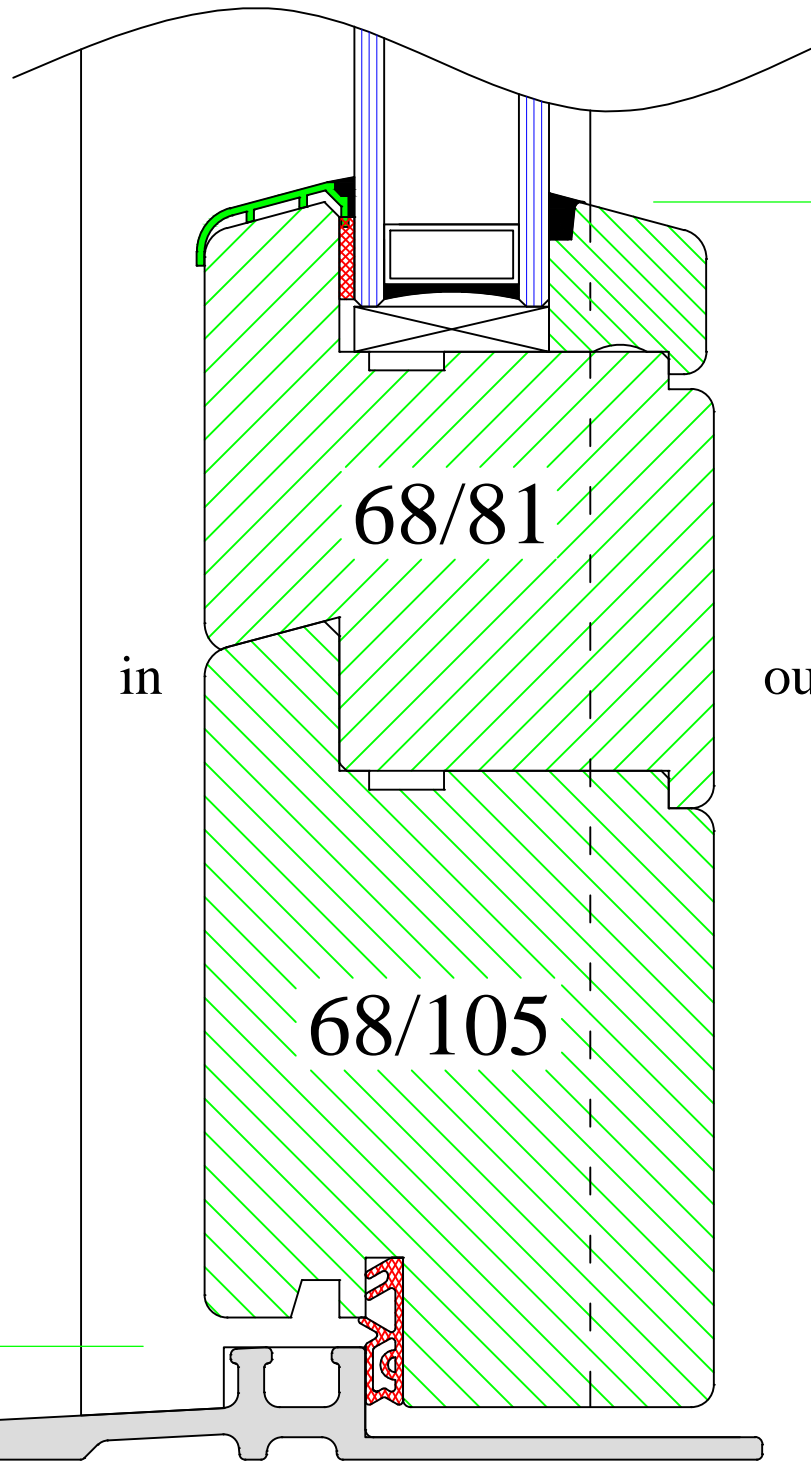

15

121

3

7

168

Y

www.uniwin.co.uk



**UNI WINDOWS Ltd.**  
 Unit 6, Edgefield Industrial Est.  
 Loanhead, EH20 9TB  
 Tel.: 0131 448 3931

IV 68 NEWLINE

French door with ULT threshold

Version:  
1

Scale:  
1:1

Date:  
15.05.14

Drawing:  
NN/40

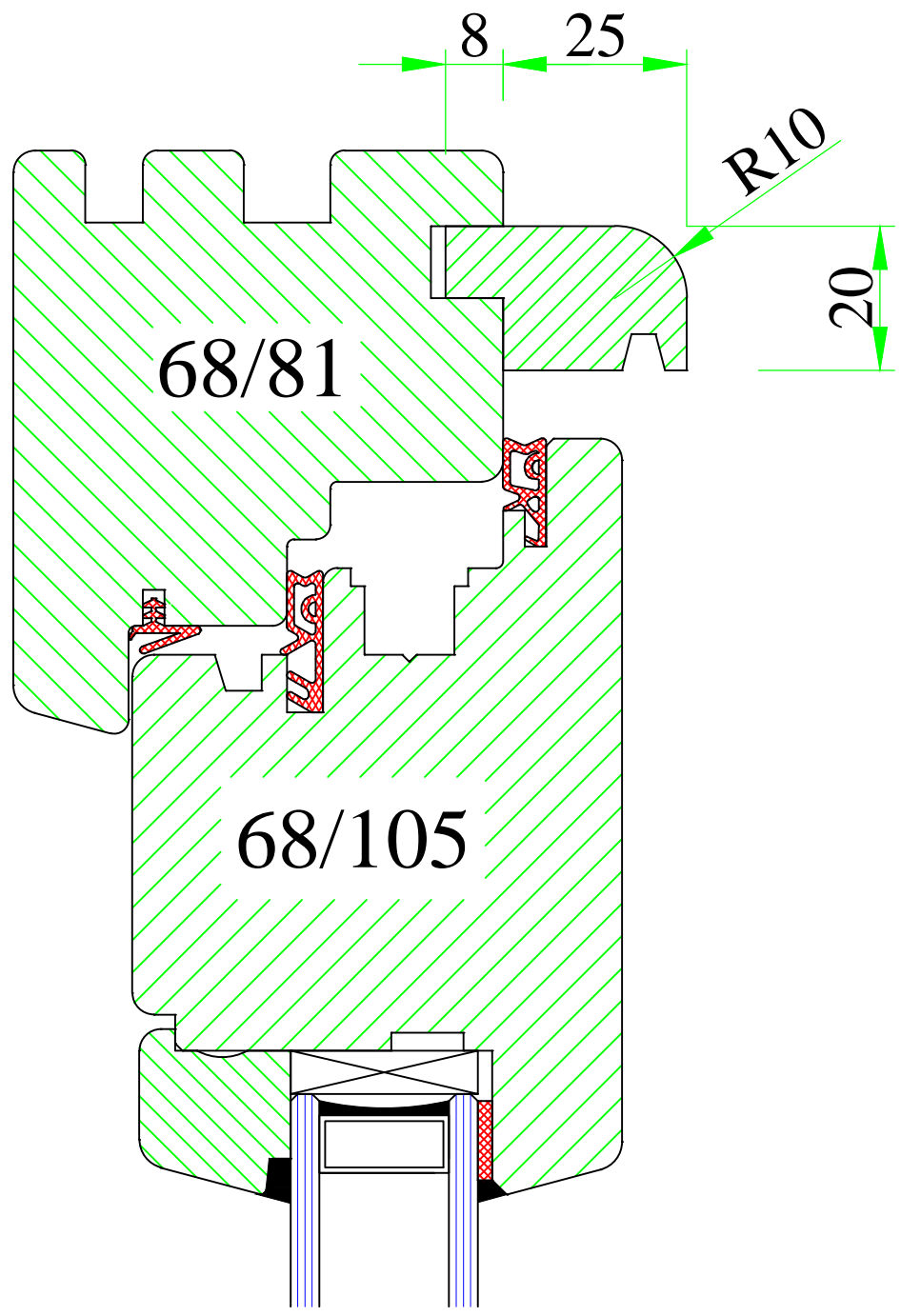
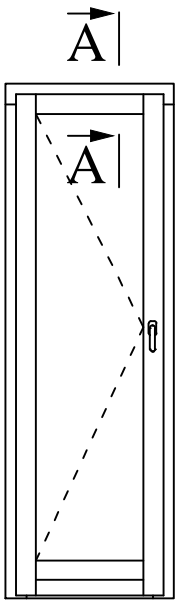

www.uniwin.co.uk



**UNI WINDOWS Ltd.**  
 Unit 6, Edgefield Industrial Est.  
 Loanhead, EH20 9TB  
 Tel.: 0131 448 3931

Wooden drip cap

IV 68 NEWLINE

Version: 1	Scale: 1:2
Date: 15.05.14	Drawing: NON/33

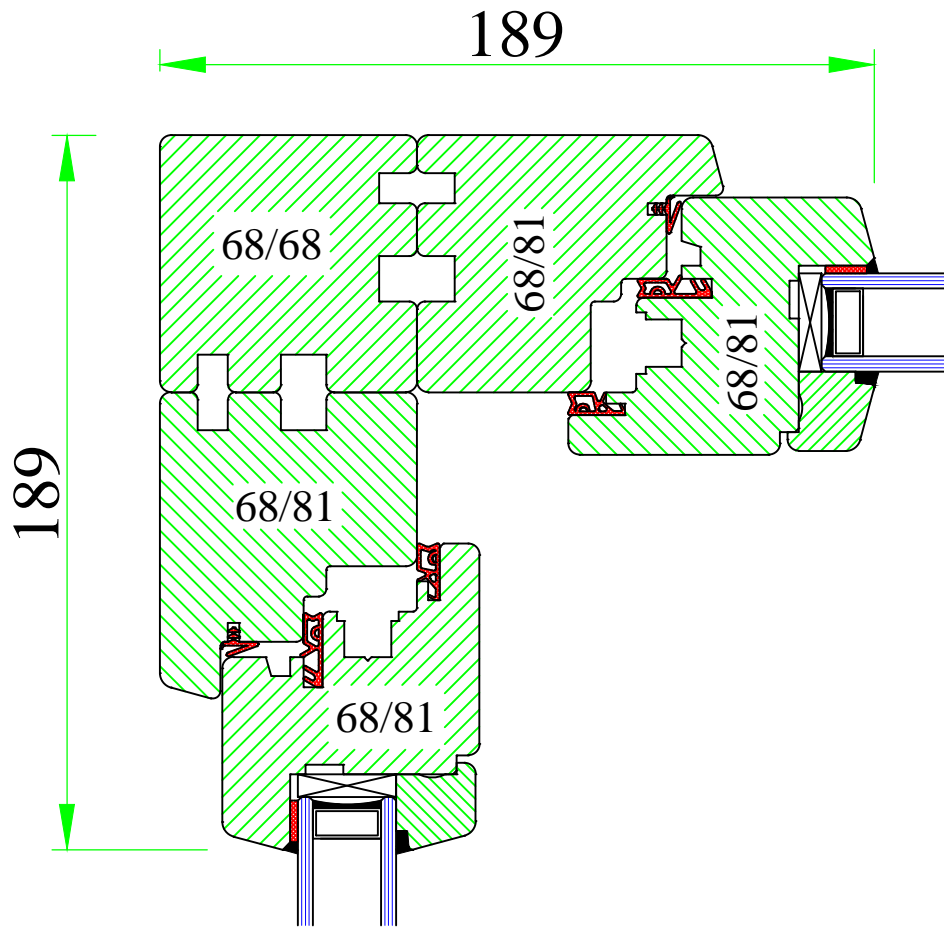

# N/37

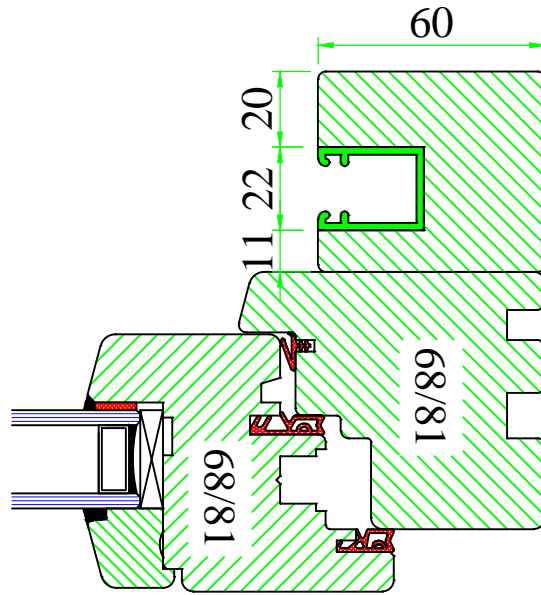

# N/37/1

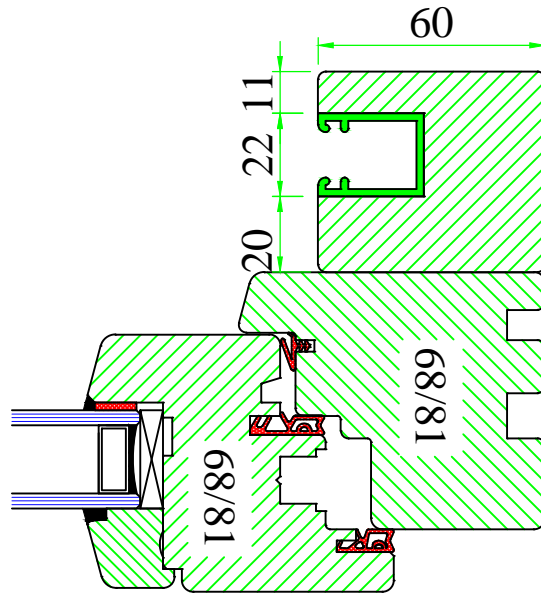

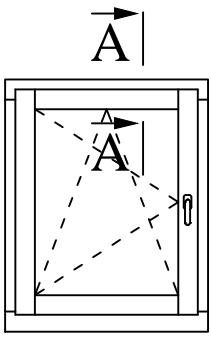

A

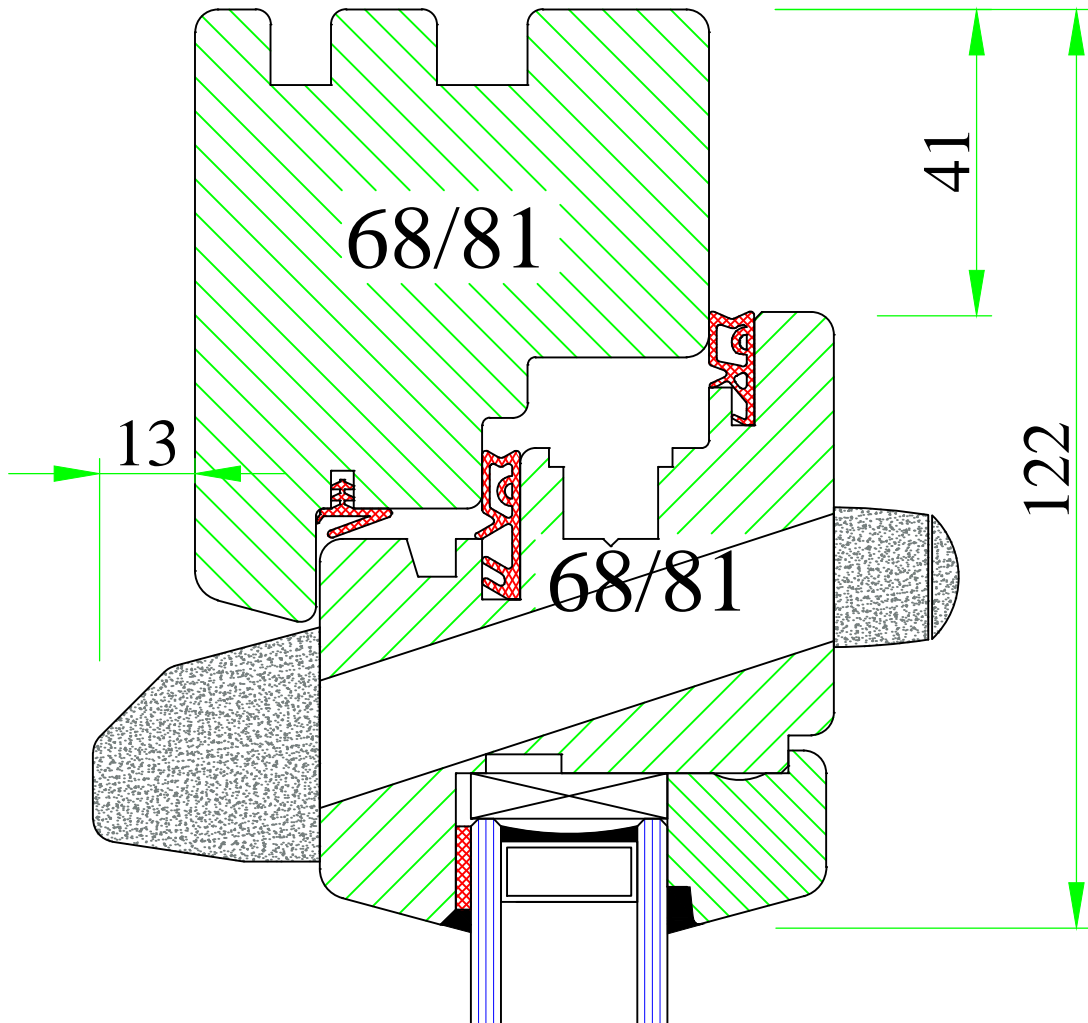

68/81

41

13

122

68/81



**UNI WINDOWS Ltd.**  
 Unit 6, Edgefield Industrial Est.  
 Loanhead, EH20 9TB  
 Tel.: 0131 448 3931

IV 68 NEWLINE  
 Ventilator S13 & ventilation inlet PC15

Version: 1	Scale: 1:2
Date: 15.05.14	Drawing: NON/38

